

ARTESYN CSU2000AP SERIES

2000 Watts Distributed Power System



PRODUCT DESCRIPTION

Advanced Energy's Artesyn CSU2000AP power supply is housed in a 1U high rack-mount enclosure measuring just 2.89 x 7.28 inches (73.5 x 185.0 mm). This form factor is significantly narrower and shorter than that of similarly rated earlier generation power supplies — freeing up valuable system space — and is achieved by use of the latest power switching technology and high density component packaging techniques. This form factor conforms to the standard market's Common Redundant Power Supplies.

SPECIAL FEATURES

- 2000W output power
- 1U power supply
- Ultra high density design
- Active power factor correction
- EN61000-3-2 harmonic compliance
- Inrush current control
- 80 PLUS® Platinum efficiency
- N+N, N+1 redundant
- Hot-pluggable
- Active current sharing
- Closed loop throttle
- Cold redundancy
- Two-year warranty
- RoHS
- Forward and reverse air options
- PMBus™ compliant

SAFETY

- UL/cUL
- CB Test Certification
- CE Mark
- CQC
- BSMI
- KC
- EAC
- BIS

TYPICAL APPLICATIONS

- Industrial

AT A GLANCE

Total Power

2000 Watts

Input Voltage

90 to 127 Vac

180 to 264 Vac

164 to 320 Vdc

of Outputs

Main and Standby



MODEL NUMBERS

Standard	Input Voltage	Output Voltage	Minimum Load ²	Maximum Load	Stand-By Supply	Air Flow Direction
CSU2000AP-3-100 ¹	90-127Vac 180-264Vac	12.2Vdc	1A	163.9A	12.0Vdc@3.5A	Normal (DC Connector to Handle)
CSU2000AP-3-111 ¹	90-127Vac 180-264Vac	12.2Vdc	1A	163.9A	12.0Vdc@3.5A	Reversed (Handle to DC Connector)
CSU2000AP-3-200	180-264Vac	12.2Vdc	1A	163.9A	12.0Vdc@3.5A	Normal (DC Connector to Handle)
CSU2000AP-3-211	180-264Vac	12.2Vdc	1A	163.9A	12.0Vdc@3.5A	Reversed (Handle to DC Connector)

Note 1 - Output power limited at 1400W at 120Vac; linearly derated to 1250W at 100Vac. Output power limited by 10A input current from 200-240Vac, typically 2000W at 200Vac.

Note 2 - 1A minimum current for transient load response testing only. Unit is designed to operate and be within output regulation range at zero load.

Options

None

ELECTRICAL SPECIFICATIONS

Absolute Maximum Ratings

Stress in excess of those listed in the “Absolute Maximum Ratings” may cause permanent damage to the power supply. These are stress ratings only and functional operation of the unit is not implied at these or any other conditions above those given in the operational sections of this TRN. Exposure to any absolute maximum rated condition for extended periods may adversely affect the power supply’s reliability.

Table 1. Absolute Maximum Ratings							
Parameter	Models	Symbol	Min	Typ	Max	Unit	
Input Voltage	CSU2000AP-3-100 CSU2000AP-3-111	$V_{IN,AC}$	90 180	- -	127 264	Vac Vac	
	AC continuous operation	CSU2000AP-3-200 CSU2000AP-3-211	$V_{IN,AC}$	180	-	264	Vac
	DC continuous operation	All models	$V_{IN,DC}$	164	-	320 ⁷	Vdc
Maximum Output Power	All models	$P_{O,max}$	-	-	2000	W	
Isolation Voltage	Input to outputs	All models	-	-	4243	Vdc	
	Input to safety ground	All models	-	-	2876	Vdc	
Ambient Operating Temperature	CSU2000AP-3-100 ¹ CSU2000AP-3-200 ¹	T_A	-5	-	65	°C	
	CSU2000AP-3-111 ² CSU2000AP-3-211 ²	T_A	-5	-	50	°C	
Storage Temperature	All models	T_{STG}	-40	-	70	°C	
Humidity (non-condensing)	Operating	All models	5	-	95	%	
	Non-operating	All models	5	-	95	%	
Altitude ³	Operating	All models	-	-	10000	Feet	
		All models	-	-	3050	Meters	
	Non-operating	All models	-	-	39700	Feet	
	All models		-	-	12100	Meters	
MTBF ⁴	All models		500	-	-	KHours	
Operating Life ⁵	All models		5	-	-	Years	
Fan L10 Life ⁶	All models		70	-	-	KHours	

Note 1 - -5°C to 55°C full rated power and derated power from 55°C to 65°C.
 Note 2 - -5°C to 40°C full rated power and derated power from 40°C to 50°C.
 Note 3 - Safety creepage/clearance rated for 5,000m altitude for CQC. Output power or ambient temperature is derated after 10000 feet.
 Note 4 - It is calculated under 50°C ambient temperature (40°C for reverse air), typical input, 100% $I_{O,max}$
 Note 5 - It is calculated under 50°C ambient temperature (40°C for reverse air) and 85% $I_{O,max}$, sea level.
 Note 6 - It is calculated under 40°C ambient temperature.
 Note 7 - 320Vdc is peak voltage.

ELECTRICAL SPECIFICATIONS

Input Specifications

Table 2. Input Specifications						
Parameter	Condition	Symbol	Min	Typ	Max	Unit
Operating Input Voltage, AC	All	$V_{IN,AC}$	90 180	115 230	127 264	Vac Vac
Operating Input Voltage, DC	All	$V_{IN,DC}$	164	240	320	Vdc
Input AC Frequency	All	$f_{IN,AC}$	47	50/60	63	Hz
Maximum Input Current ($I_O = I_{O,max}$, $I_{SB} = I_{SB,max}$)	$V_{IN,AC} = 90Vac$ (C14) $V_{IN,AC} = 100Vac$ (C14) $V_{IN,AC} = 180Vac$ (C14) $V_{IN,AC} = 180Vac$ (C20) $V_{IN,AC} = 200Vac$ (C14) $V_{IN,AC} = 200Vac$ (C20) $V_{IN,AC} = 240Vac$ (C20)	$I_{IN,max}$	- - - - - - -	- - - - - - -	16.2 14.4 11.2 12.5 10.0 11.2 9.3	A A A A A A A
No Load Input Current ($V_O = On$, $I_O = 0A$, $I_{SB} = 0A$)	$V_{IN,AC} = 90Vac$ (C14) $V_{IN,AC} = 180Vac$ (C20)	$I_{IN,no-load}$	- -	200 100	- -	mA mA
No Load Input Power ($V_O = On$, $I_O = 0A$, $I_{SB} = 0A$)	$V_{IN,AC} = 90Vac$ (C14) $V_{IN,AC} = 180Vac$ (C20)	$P_{IN,no-load}$	- -	6 6	- -	W W
Standby Input Current ($V_O = Off$, $I_{SB} = 0A$)	$V_{IN,AC} = 90Vac$ (C14) $V_{IN,AC} = 180Vac$ (C20)	$I_{IN,Standby}$	- -	200 100	- -	mA mA
Standby Input Power ($V_O = Off$, $I_{SB} = 0A$)	$V_{IN,AC} = 90Vac$ (C14) $V_{IN,AC} = 180Vac$ (C20)	$P_{IN,Standby}$	- -	6 6	- -	W W
Input iTHD (100-127Vac, 200-240Vac, 50Hz/60Hz)	$I_O = 5$ to $10\%I_{O,max}$ $I_O = 11$ to $20\%I_{O,max}$ $I_O = 21$ to $50\%I_{O,max}$ $I_O > 50\%I_{O,max}$	iTHD	- - - -	- - - -	25 10 8 3.5	%
Power Factor	$I_O = 10\%I_{O,max}$ $I_O = 20\%I_{O,max}$ $I_O = 50\%I_{O,max}$ $I_O = 100\%I_{O,max}$	PF	0.90 0.96 0.98 0.99	- - - -	- - - -	
Startup Surge Current (Inrush) ¹ @ 25°C	$V_{IN,AC} = 264Vac$	$I_{IN,surge}$	-	-	35	Apk
Input Fuse	Internal, L 5x20mm, Quick Acting 20A, 420Vdc		-	-	20	A
Leakage Current to Earth Ground	$V_{IN,AC} = 264Vac$ $f_{IN,AC} = 60Hz$		-	-	0.583	mA
Turn-on Voltage Minimum of 5V hysteresis	AC Low Line (C14) AC High Line (C14) AC High Line (C20) DC Input	$V_{IN,AC}$ $V_{IN,DC}$	75 165 165 155	- - - -	90 180 180 164	Vac Vac Vac Vdc
Turn-off Voltage Minimum of 5V hysteresis	AC Low Line (C14) AC High Line (C14) AC High Line (C20) DC Input	$V_{IN,AC}$ $V_{IN,DC}$	65 165 165 155	- - - -	84 174 174 164	Vac Vac Vac Vdc

Note 1 - The input peak current will not exceed 35A peak when the power supply input is cycled between on and off states at 240Vac, where the off state is not more than one full AC cycle at half load or 1/2 cycle at full load. The AC input can return at any phase. Peak currents greater than 35A, during the input recovery period, should not exceed 70A and not have a duration of more than 200us above 35A.

ELECTRICAL SPECIFICATIONS

Input Specifications

Table 2. Input Specifications con't						
Parameter	Condition	Symbol	Min	Typ	Max	Unit
Input Under Voltage Warning	AC Low Line (C14)	$V_{IN,AC}$	85	-	87	Vac
	AC High Line (C14)		175	-	177	Vac
	AC High Line (C20)		175	-	177	Vac
	DC Input	$V_{IN,DC}$	175	-	177	Vdc
Operating Efficiency @ 25°C	$V_{IN,AC} = 115Vac$ $f_{IN,AC} = 50Hz$ $I_O = 10\%I_{O,max}$ $I_O = 20\%I_{O,max}$ $I_O = 50\%I_{O,max}$ $I_O = 100\%I_{O,max}$	η	80	-	-	%
			85	-	-	%
			92	-	-	%
			89	-	-	%
	$V_{IN,AC} = 230Vac$ $f_{IN,AC} = 50Hz$ $I_O = 10\%I_{O,max}$ $I_O = 20\%I_{O,max}$ $I_O = 50\%I_{O,max}$ $I_O = 100\%I_{O,max}$	η	88	-	-	%
			91	-	-	%
			94	-	-	%
			91	-	-	%
System Stability	Phase Margin Gain Margin		45	-	-	°
			-6	-	-	dB

ELECTRICAL SPECIFICATIONS

Output Specifications

Table 3. Output Specifications						
Parameter	Condition	Symbol	Min	Typ	Max	Unit
Factory Set Voltage	$V_{IN,AC} = 230Vac$ $I_O = 50\%I_{O,max}$ $I_{SB} = 50\%I_{SB,max}$ $T_A = 25^{\circ}C$	$\%V_O$	-0.2	-	0.2	%
		$\%V_{SB}$	-2.5	-	2.5	
Output Regulation	Inclusive of set-point, temperature change, warm-up drift and dynamic load	$\%V_O$	-5	-	5	%
		$\%V_{SB}$	-5	-	5	
Output Ripple, Pk-Pk	Measure with a 0.1 μ F ceramic capacitor in parallel with a 10 μ F tantalum capacitor, 10 to 20MHz bandwidth	V_O	-	-	120	mV _{PK-PK}
		V_{SB}	-	-	120	
Output Current ^(1,2)	$V_{IN,AC} = 90-127Vac$ $V_{IN,AC} = 180-264Vac$	I_O	0 0	- -	114.7 163.9	A
	All	I_{SB}	0	-	3.5	
Main Output Current Share Accuracy ³ Standby Output Current Share Accuracy ⁴	25% to 100% $I_{O,max}$	$\%I_O$	-	-	6	%
Number of Parallel Units	Main output current share connected		-	-	4	Units
Load Capacitance	Start up and stability	C_O	-	-	50000	uF
	Cold redundancy and dynamic load		2000	-	-	
	Support peak current ⁵		18000	-	-	
	Standby output start up	C_{SB}	47	-	3100	
V_O Dynamic Response ⁶ Peak Deviation	60% load change, slew rate = 0.5A/us	V_O	11.6	-	12.8	V
	1A load change, slew rate = 0.5A/us	V_{SB}	11.4	-	12.6	V

Note 1 - Permissible overload of up to 253A under short-term conditions. See over-current protection section.
 Note 2 - 1A Minimum current for transient load response testing only. Unit is designed to operate and be within output regulation range at zero load.
 Note 3 - The current sharing function start when the total system load has reached 7% of the power supply rating.
 Note 4 - Two power supplies can only current share to a total of 4.1A load on the standby output. Current sharing will also not be guaranteed to be accurate but the standby will not shutdown. If the load exceeds 4.1A, automatically lose redundancy because the standby output of one PSU fails, the remaining PSU will enter into OCP mode because of the excessive current.
 Note 5 - For fast OCP/OCW, slow OCP/OCW.
 Note 6 - Load changes from minimum to maximum or maximum to minimum may cause output voltage to go out of regulation but will not cause the power supply to shut down. Minimum allowable output capacitance applies.

ELECTRICAL SPECIFICATIONS

System Timing Specifications

Table 4. System Timing Specifications					
Label	Parameter	Min	Typ	Max	Unit
T1	Delay from AC being applied to 12V V_{SB} being within regulation.	-	-	1500	mSec
T2	Delay from AC being applied to all output voltages being within regulation.	-	-	3000	mSec
T3	Output voltage rise time for 12V V_O from 10% to within regulation limits, the same for 12V V_{SB} .	10	-	70	mSec
dV/dt	Applies to both 12V V_O and 12V V_{SB} only when set to the 25ms default rise time. This requirement does not apply when risetimes are set for <25ms.	-	-	0.5	V/mSec
T4	Delay from output voltages within regulation limits to PWOK asserted high at turn on.	100	-	500	mSec
T5	Delay from loss of AC to de-assertion of PWOK.	10	-	-	mSec
T6	Delay from PWOK de-asserted to output voltages dropping out of regulation limits.	1	-	-	mSec
T7	Hold up time - time output voltages stay within regulation after the loss of AC.	11	-	-	mSec
T8	Delay from standby voltage in regulation to output voltage in regulation at AC turn on.	50	-	1000	mSec
T9	Duration of PWOK being in the de-asserted state during an off/on cycle using AC or the PSON signal.	100	-	-	mSec
T10	Delay from PSON active to output voltages within regulation limits.	5	-	400	mSec
T11	Delay from PSON deactive to PWOK de-asserted low.	-	-	5	mSec
T12	Hold up time - time standby voltages stay within regulation after the loss of AC.	70	-	-	mSec
T13	Delay from input being applied to VIN_GOOD assertion.	-	-	1800	mSec
T14	Delay from loss of AC to de-assertion of VIN_GOOD.	-	-	3	mSec
T15	This is the time the PSU must stay off when being powered off with loss of AC input. Both outputs must meet this OFF time: 1) whenever PWOK is de-asserted for the 12V V_O ; 2) whenever the 12V V_{SB} output drops below regulation limits.	500	-	-	mSec
T16	Delay from PSON de-asserted to power supply turning off.	-	-	5	mSec

Note 1 - T12 is supported when the total output power does not exceed max. total combined (12V + 12Vsb) power output, and the 12Vsb load is at 1.75A.
 Note 2 - To recycle the power supply, the input power must be kept off for >1 sec to ensure restart.

ELECTRICAL SPECIFICATIONS

System Timing Diagram

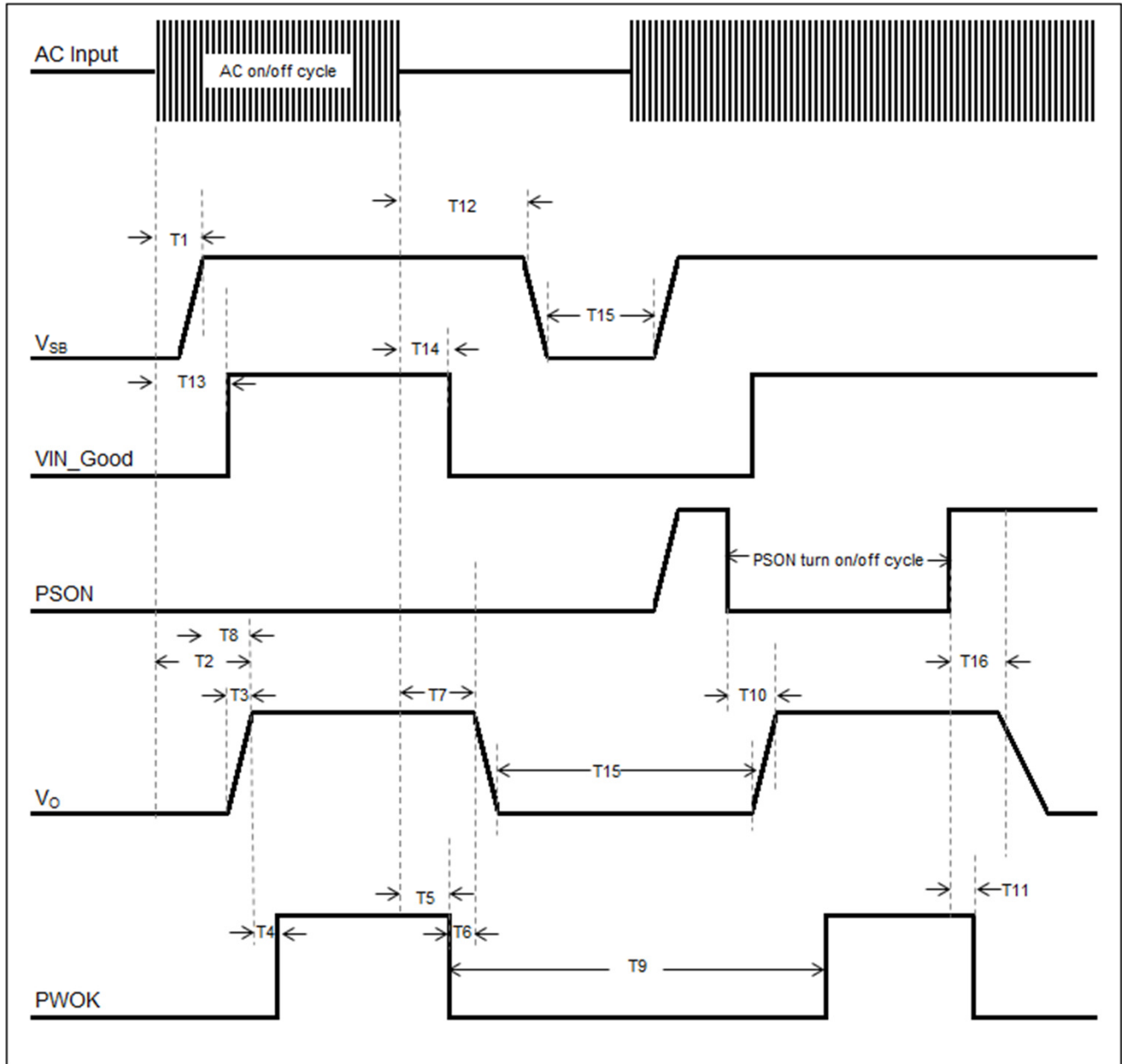

ELECTRICAL SPECIFICATIONS

CSU2000AP-3-100 Performance Curves

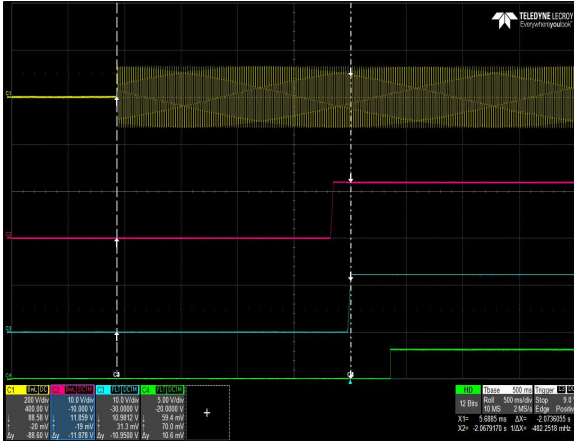

Figure 1: CSU2000AP-3-100 Turn-On Delay via AC Mains
 Vin = 90Vac Load: $I_O = 102.5A$ $I_{SB} = 3.5A$
 Ch 1: AC Mains Ch 2: V_{SB} Ch 3: V_O Ch 4: PWOK

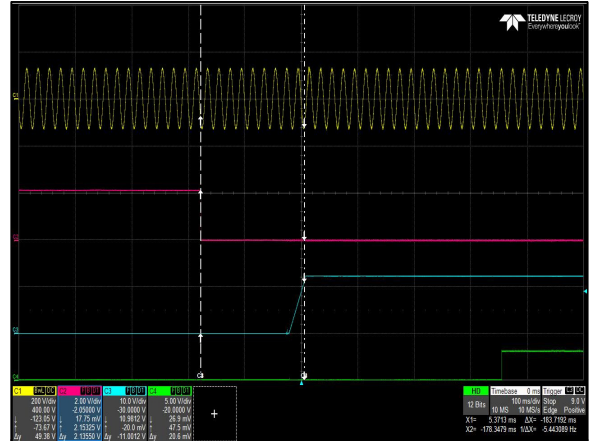

Figure 2: CSU2000AP-3-100 Turn-On Delay via PSON
 Vin = 90Vac Load: $I_O = 102.5A$ $I_{SB} = 3.5A$
 Ch 1: AC Mains Ch 2: PSON Ch 3: V_O Ch 4: PWOK

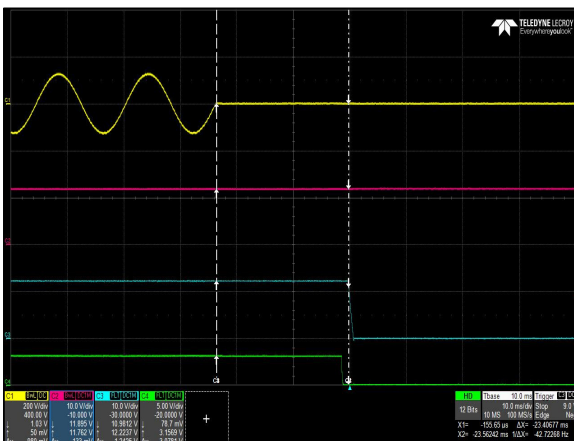

Figure 3: CSU2000AP-3-100 Hold-Up Time
 Vin = 90Vac Load: $I_O = 102.5A$ $I_{SB} = 3.5A$
 Ch 1: AC Mains Ch 2: V_{SB} Ch 3: V_O Ch 4: PWOK

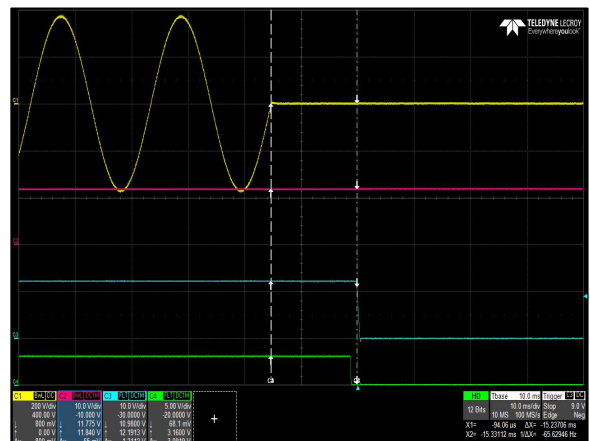

Figure 4: CSU2000AP-3-100 Hold-Up Time
 Vin = 264Vac Load: $I_O = 163.9A$ $I_{SB} = 3.5A$
 Ch 1: AC Mains Ch 2: V_{SB} Ch 3: V_O Ch 4: PWOK

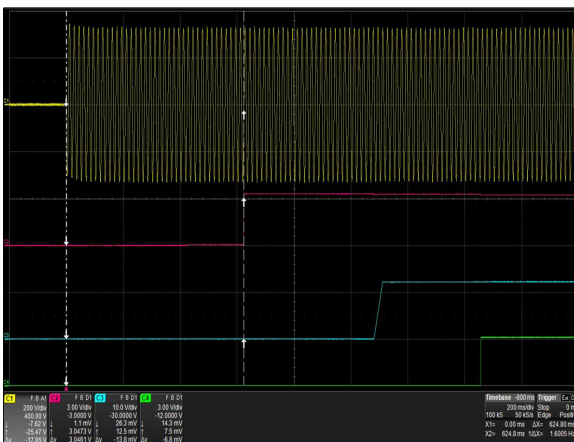

Figure 5: CSU2000AP-3-100 VIN_GOOD Assert Characteristic
 Vin = 230Vac Load: $I_O = 163.9A$ $I_{SB} = 3.5A$
 Ch 1: AC Mains Ch 2: VIN_GOOD Ch 3: V_O Ch 4: PWOK

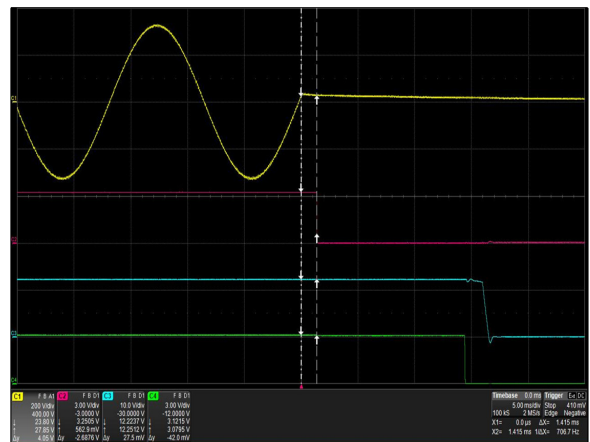

Figure 6: CSU2000AP-3-100 VIN_GOOD De-assert Characteristic
 Vin = 230Vac Load: $I_O = 163.9A$ $I_{SB} = 3.5A$
 Ch 1: AC Mains Ch 2: VIN_GOOD Ch 3: V_O Ch 4: PWOK

ELECTRICAL SPECIFICATIONS

CSU2000AP-3-100 Performance Curves

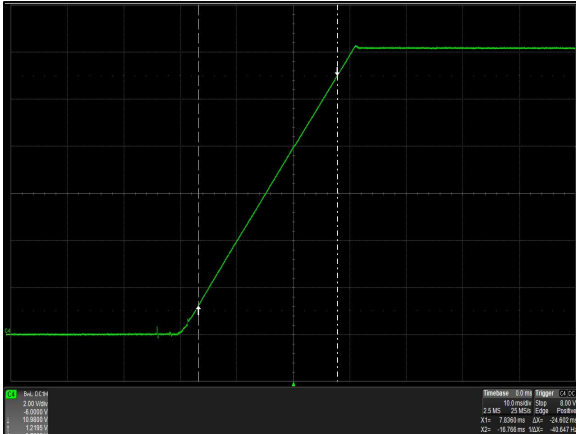

Figure 7: CSU2000AP-3-100 Output Voltage Startup Characteristic
 Vin = 90Vac Load: Io = 102.5A
 Ch 4: V_O

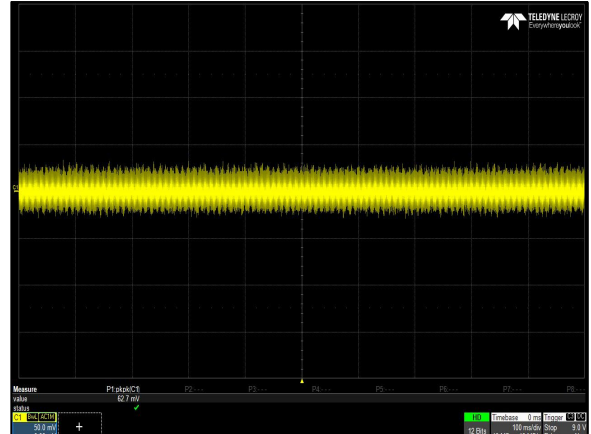

Figure 8: CSU2000AP-3-100 Ripple and Noise Measurement
 Vin = 230Vac Load: Io = 163.9A I_{SB} = 3.5A
 Ch 1: V_O

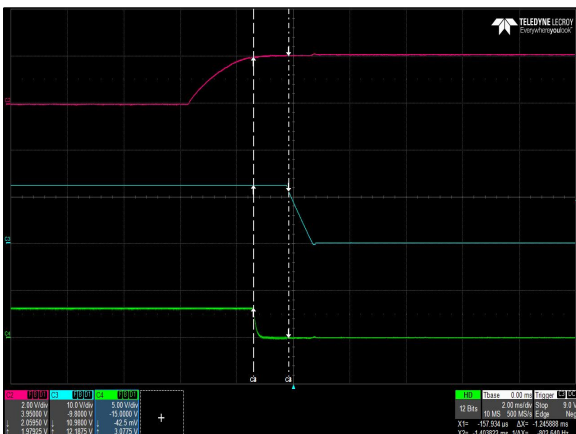

Figure 9: CSU2000AP-3-100 Turn Off Characteristic via PSON
 Load: Io = 163.9A I_{SB} = 3.5A
 Ch 2: PSON Ch 3: V_O Ch 4: PWOK

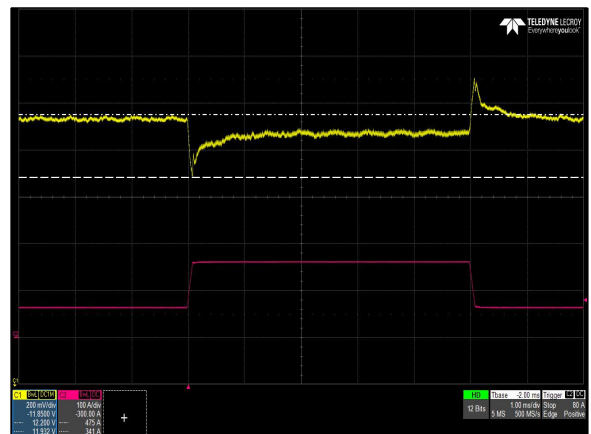

Figure 10: CSU2000AP-3-100 Transient Response - V_O Deviation
 40% to 100% load change 0.5A/μs slew rate Vin = 230Vac
 Ch 1: V_O Ch 2: I_O

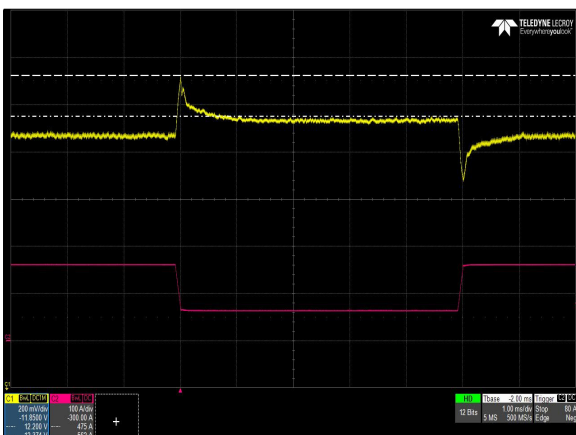

Figure 11: CSU2000AP-3-100 Transient Response - V_O Deviation
 100% to 40% load change 0.5A/μs slew rate Vin = 230Vac
 Ch 1: V_O Ch 2: I_O

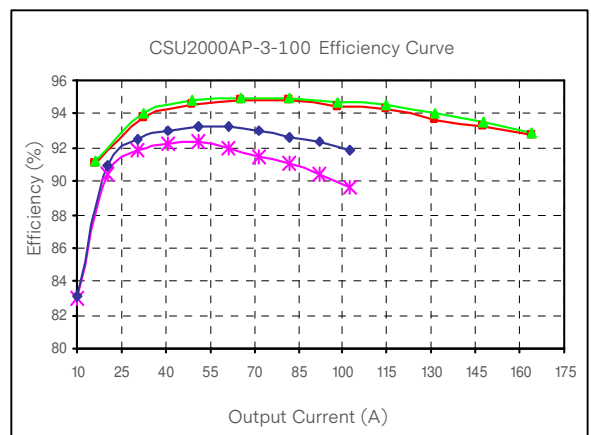

Figure 12: CSU2000AP-3-100 Efficiency Curve @ 25°C
 Loading: I_{o,min} = 10% I_{o,max} increment to I_{o,max}

ELECTRICAL SPECIFICATIONS

CSU2000AP-3-111 Performance Curves

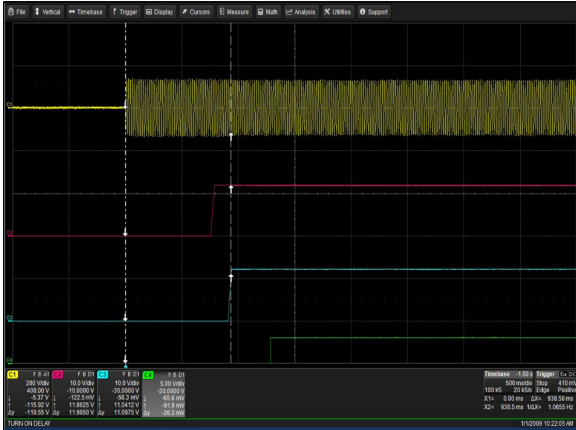

Figure 13: CSU2000AP-3-111 Turn-On Delay via AC Mains
 Vin = 90Vac Load: I_O = 102.5A I_{SB} = 3.5A
 Ch 1: AC Mains Ch 2: V_{SW} Ch 3: V_O Ch 4: PWOK

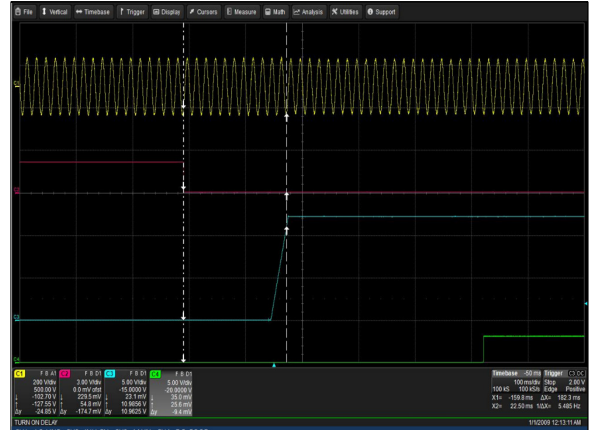

Figure 14: CSU2000AP-3-111 Turn-On Delay via PSON
 Vin = 90Vac Load: I_O = 102.5A I_{SB} = 3.5A
 Ch 1: AC Mains Ch 2: PSON Ch 3: V_O Ch 4: PWOK



Figure 15: CSU2000AP-3-111 Hold-Up Time
 Vin = 90Vac Load: I_O = 102.5A I_{SB} = 3.5A
 Ch 1: AC Mains Ch 2: V_{SW} Ch 3: V_O Ch 4: PWOK

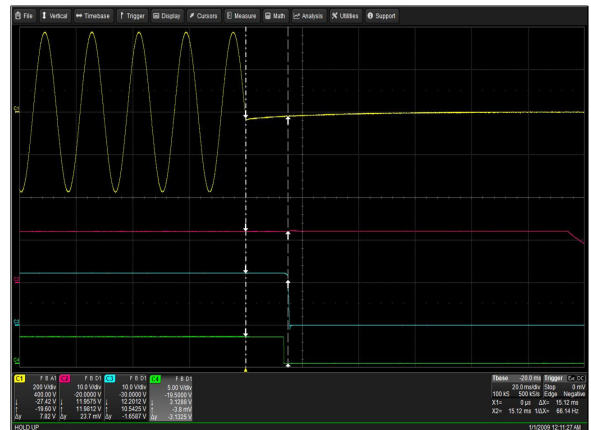

Figure 16: CSU2000AP-3-111 Hold-Up Time
 Vin = 264Vac Load: I_O = 163.9A I_{SB} = 3.5A
 Ch 1: AC Mains Ch 2: V_{SW} Ch 3: V_O Ch 4: PWOK

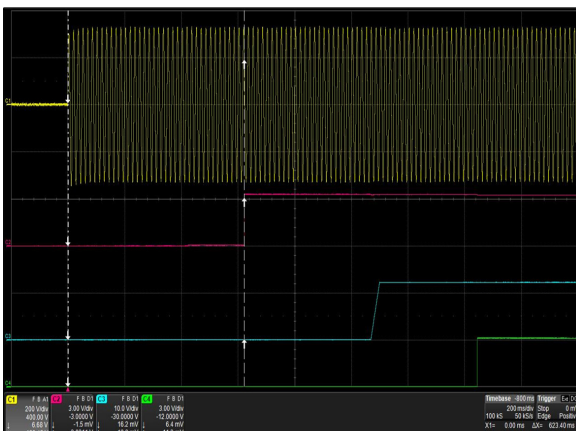

Figure 17: CSU2000AP-3-111 VIN_GOOD Assert Characteristic
 Vin = 230Vac Load: I_O = 163.9A I_{SB} = 3.5A
 Ch 1: AC Mains Ch 2: VIN_GOOD Ch 3: V_O Ch 4: PWOK

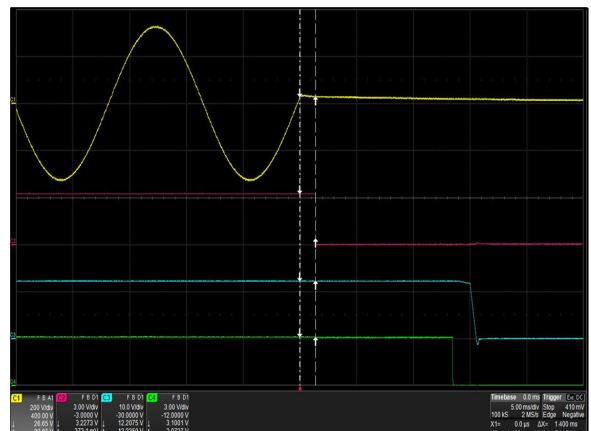

Figure 18: CSU2000AP-3-111 VIN_GOOD De-assert Characteristic
 Vin = 230Vac Load: I_O = 163.9A I_{SB} = 3.5A
 Ch 1: AC Mains Ch 2: VIN_GOOD Ch 3: V_O Ch 4: PWOK

ELECTRICAL SPECIFICATIONS

CSU2000AP-3-111 Performance Curves

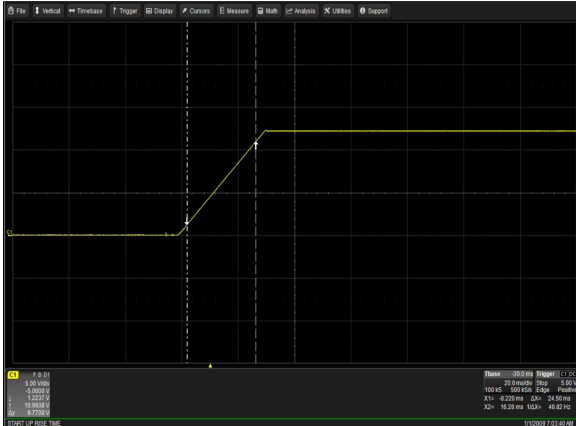

Figure 19: CSU2000AP-3-111 Output Voltage Startup Characteristic
 Vin = 90Vac Load: $I_o = 102.5A$ $I_{SB} = 3.5A$
 Ch 1: V_o

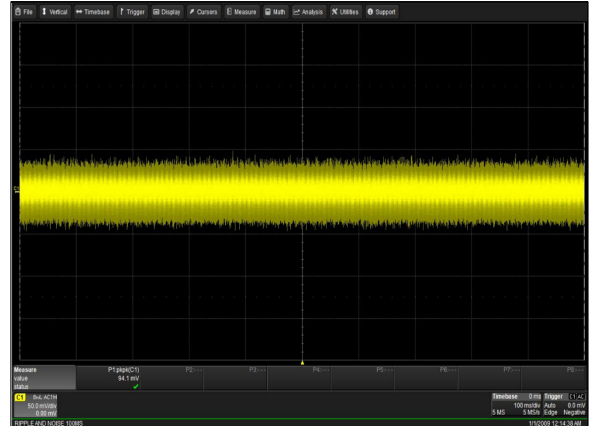

Figure 20: CSU2000AP-3-111 Ripple and Noise Measurement
 Vin = 230Vac Load: $I_o = 163.9A$ $I_{SB} = 3.5A$
 Ch 1: V_o

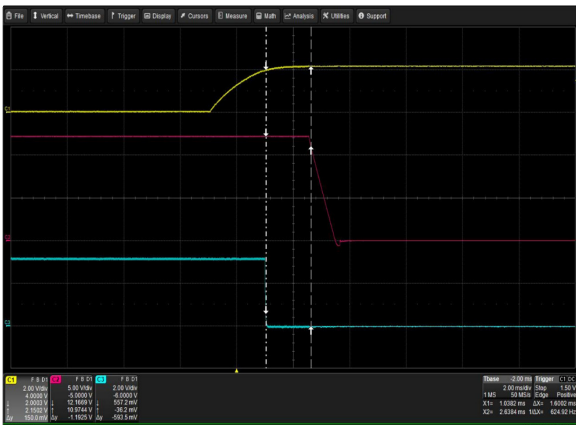

Figure 21: CSU2000AP-3-111 Turn Off Characteristic via PS_ON
 Load: $I_o = 163.9A$ $I_{SB} = 3.5A$
 Ch 1: PS_ON Ch 2: V_o Ch 3: PWOK

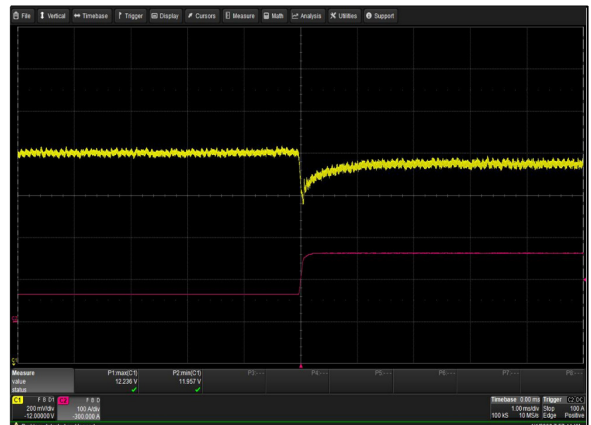

Figure 22: CSU2000AP-3-111 Transient Response - V_o Deviation
 40% to 100% load change 0.5A/ μ S slew rate Vin = 230Vac
 Ch 1: V_o Ch 2: I_o

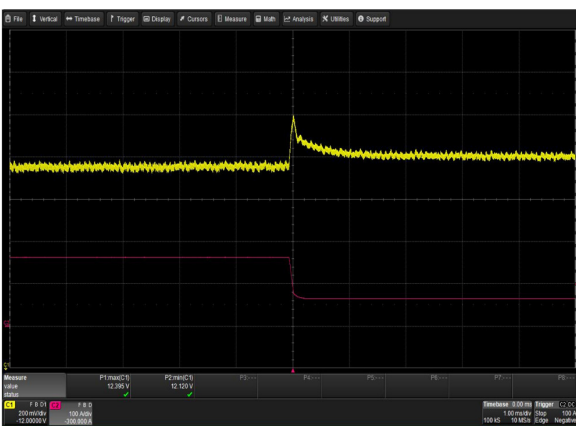

Figure 23: CSU2000AP-3-111 Transient Response - V_o Deviation
 100% to 40% load change 0.5A/ μ S slew rate Vin = 230Vac
 Ch 1: V_o Ch 2: I_o

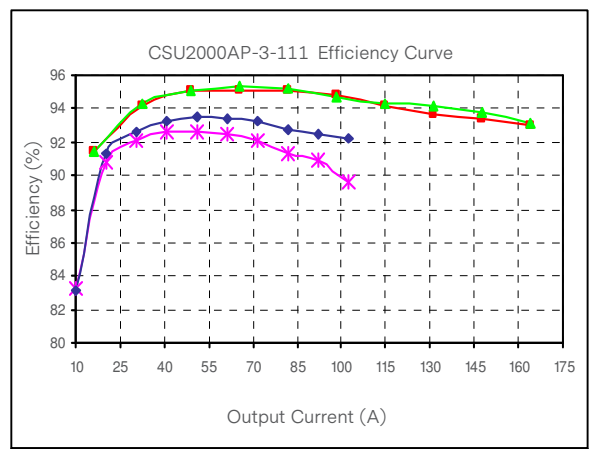

Figure 24: CSU2000AP-3-111 Efficiency Curve @ 25°C
 Loading: $I_{o,max}$ increment to $I_{o,max}$

ELECTRICAL SPECIFICATIONS

CSU2000AP-3-200 Performance Curves

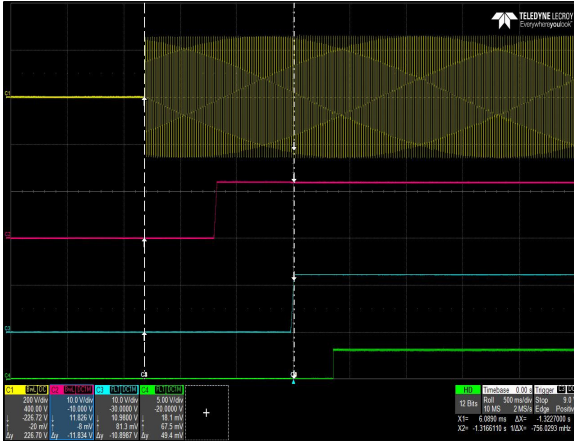

Figure 25: CSU2000AP-3-200 Turn-On Delay via AC Mains
 Vin = 180Vac Load: $I_O = 163.9A$ $I_{SB} = 3.5A$
 Ch 1: AC Mains Ch 2: V_{SB} Ch 3: V_O Ch 4: PWOK

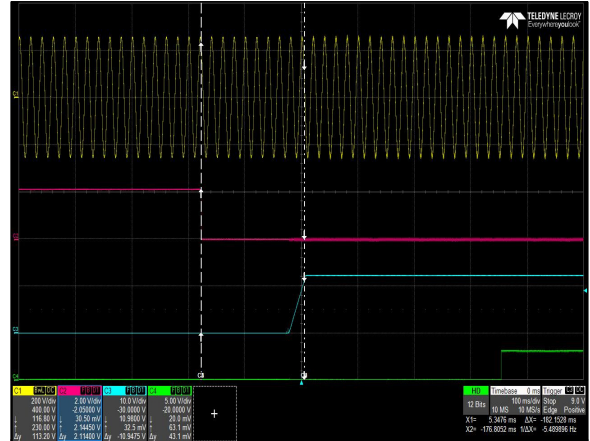

Figure 26: CSU2000AP-3-200 Turn-On Delay via PSON
 Vin = 180Vac Load: $I_O = 163.9A$ $I_{SB} = 3.5A$
 Ch 1: AC Mains Ch 2: PSON Ch 3: V_O Ch 4: PWOK

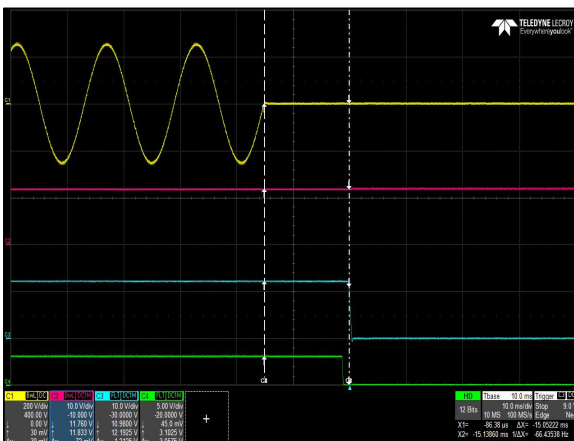

Figure 27: CSU2000AP-3-200 Hold-Up Time
 Vin = 180Vac Load: $I_O = 163.9A$ $I_{SB} = 3.5A$
 Ch 1: AC Mains Ch 2: V_{SB} Ch 3: V_O Ch 4: PWOK

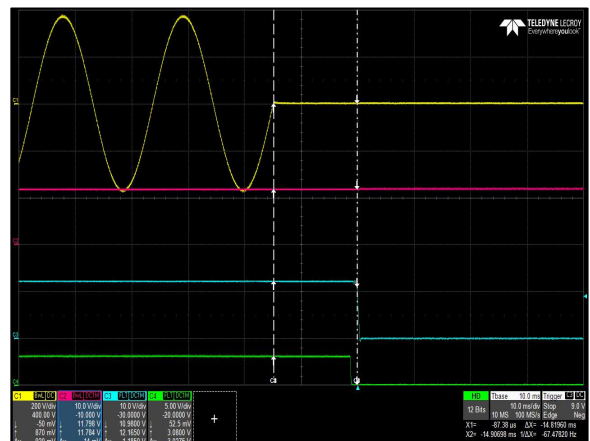

Figure 28: CSU2000AP-3-200 Hold-Up Time
 Vin = 264Vac Load: $I_O = 163.9A$ $I_{SB} = 3.5A$
 Ch 1: AC Mains Ch 2: V_{SB} Ch 3: V_O Ch 4: PWOK

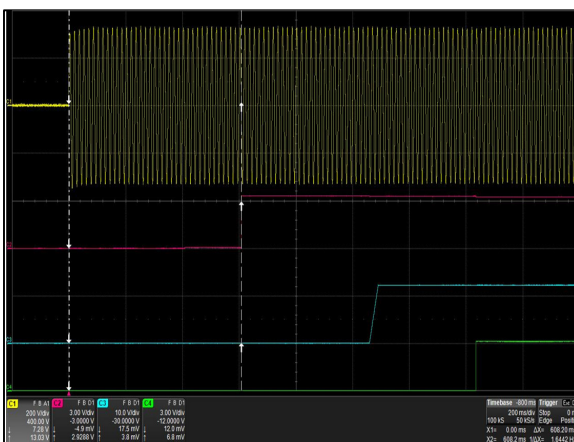

Figure 29: CSU2000AP-3-200 VIN_GOOD Assert Characteristic
 Vin = 230Vac Load: $I_O = 163.9A$ $I_{SB} = 3.5A$
 Ch 1: AC Mains Ch 2: VIN_GOOD Ch 3: V_O Ch 4: PWOK

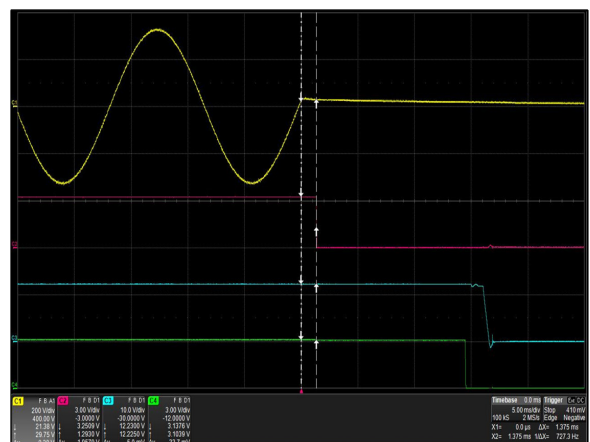

Figure 30: CSU2000AP-3-200 VIN_GOOD De-assert Characteristic
 Vin = 230Vac Load: $I_O = 163.9A$ $I_{SB} = 3.5A$
 Ch 1: AC Mains Ch 2: VIN_GOOD Ch 3: V_O Ch 4: PWOK

ELECTRICAL SPECIFICATIONS

CSU2000AP-3-200 Performance Curves

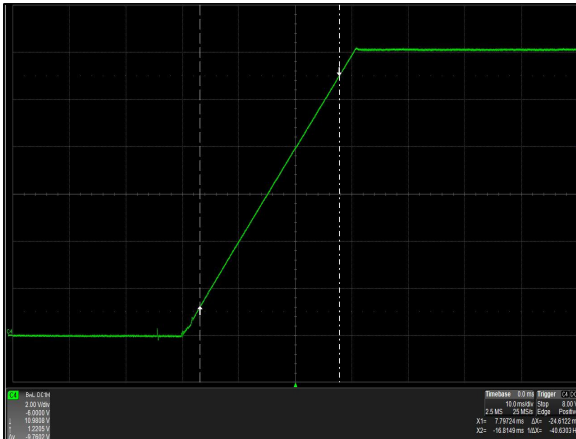

Figure 31: CSU2000AP-3-200 Output Voltage Startup Characteristic
 Vin = 180Vac Load: $I_o = 163.9A$ $I_{SB} = 3.5A$
 Ch 4: V_o

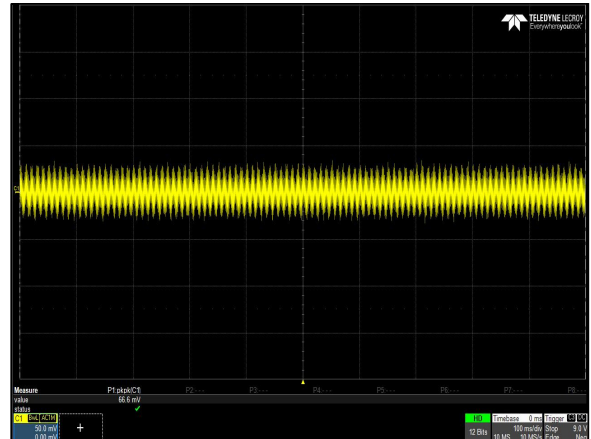

Figure 32: CSU2000AP-3-200 Ripple and Noise Measurement
 Vin = 230Vac Load: $I_o = 163.9A$ $I_{SB} = 3.5A$
 Ch 1: V_o

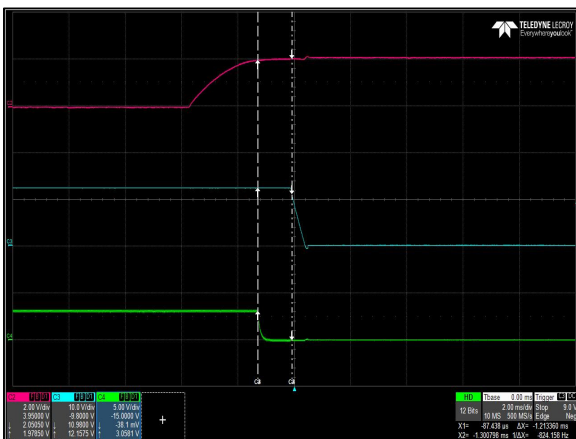

Figure 33: CSU2000AP-3-200 Turn Off Characteristic via PSON
 Load: $I_o = 163.9A$ $I_{SB} = 3.5A$
 Ch 2: PSON Ch 3: V_o Ch 4: PWOK

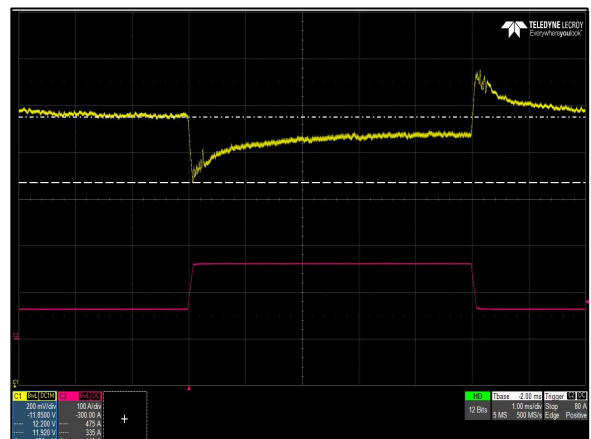

Figure 34: CSU2000AP-3-200 Transient Response - V_o Deviation
 40% to 100% load change 0.5A/uS slew rate Vin = 230Vac
 Ch 1: V_o Ch 2: I_o

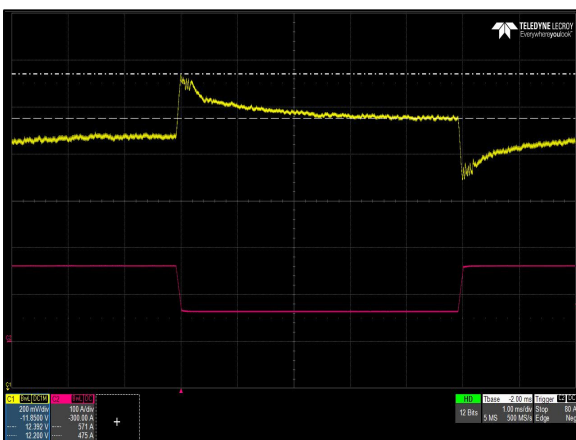

Figure 35: CSU2000AP-3-200 Transient Response - V_o Deviation
 100% to 40% load change 0.5A/uS slew rate Vin = 230Vac
 Ch 1: V_o Ch 2: I_o

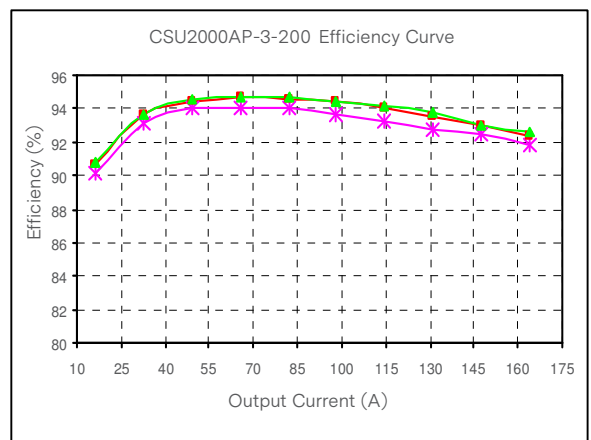

Figure 36: CSU2000AP-3-200 Efficiency Curve @ 25°C
 Loading: $I_{o_main} = 10\%I_{o_max}$ increment to I_{o_max}

ELECTRICAL SPECIFICATIONS

CSU2000AP-3-211 Performance Curves

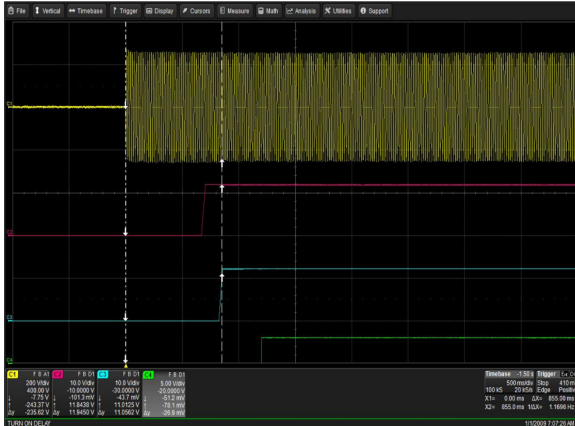

Figure 37: CSU2000AP-3-211 Turn-On Delay via AC Mains
 Vin = 180Vac Load: I_O = 163.9A I_{SB} = 3.5A
 Ch 1: AC Mains Ch 2: V_{SB} Ch 3: V_O Ch 4: PWOK

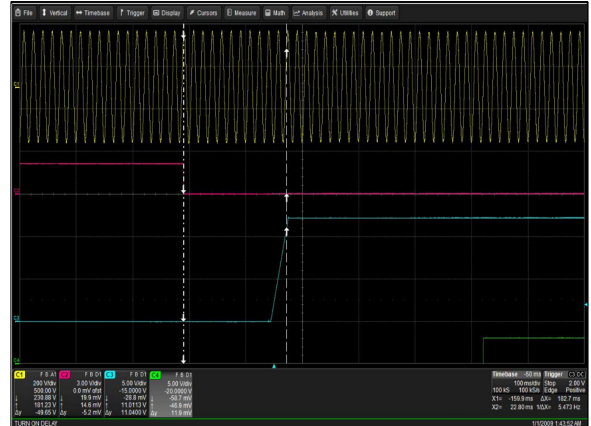

Figure 38: CSU2000AP-3-211 Turn-On Delay via PSON
 Vin = 180Vac Load: I_O = 163.9A I_{SB} = 3.5A
 Ch 1: AC Mains Ch 2: PSON Ch 3: V_O Ch 4: PWOK

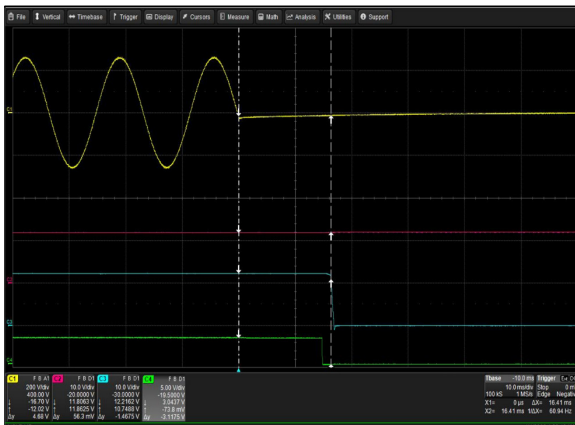

Figure 39: CSU2000AP-3-211 Hold-Up Time
 Vin = 180Vac Load: I_O = 163.9A I_{SB} = 3.5A
 Ch 1: AC Mains Ch 2: V_{SB} Ch 3: V_O Ch 4: PWOK

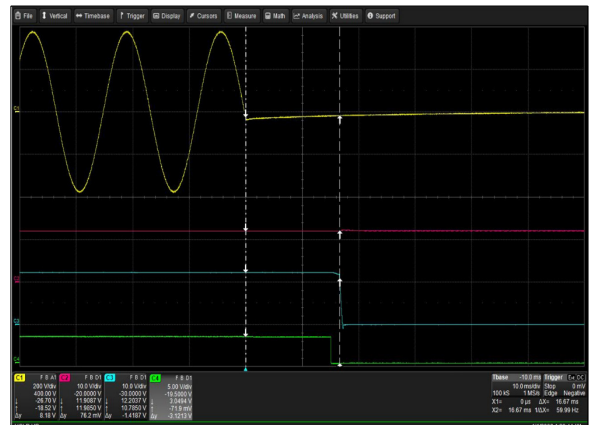

Figure 40: CSU2000AP-3-211 Hold-Up Time
 Vin = 264Vac Load: I_O = 163.9A I_{SB} = 3.5A
 Ch 1: AC Mains Ch 2: V_{SB} Ch 3: V_O Ch 4: PWOK

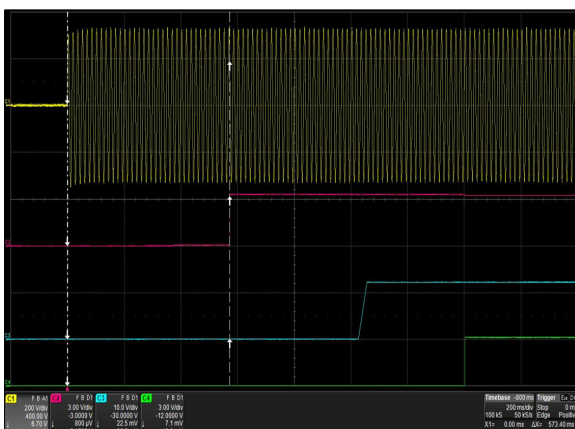

Figure 41: CSU2000AP-3-211 VIN_GOOD Assert Characteristic
 Vin = 230Vac Load: I_O = 163.9A I_{SB} = 3.5A
 Ch 1: AC Mains Ch 2: VIN_GOOD Ch 3: V_O Ch 4: PWOK

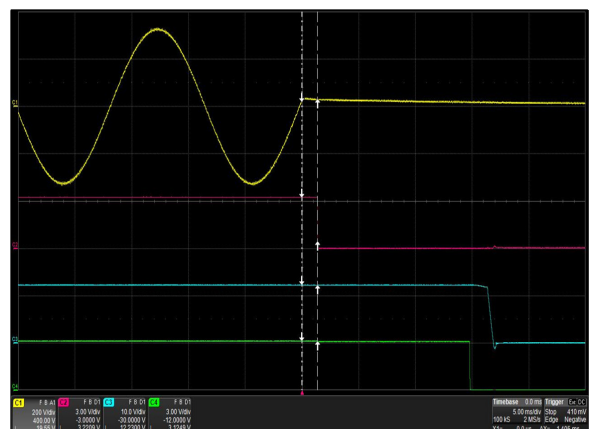

Figure 42: CSU2000AP-3-211 VIN_GOOD De-assert Characteristic
 Vin = 230Vac Load: I_O = 163.9A I_{SB} = 3.5A
 Ch 1: AC Mains Ch 2: VIN_GOOD Ch 3: V_O Ch 4: PWOK

ELECTRICAL SPECIFICATIONS

CSU2000AP-3-211 Performance Curves

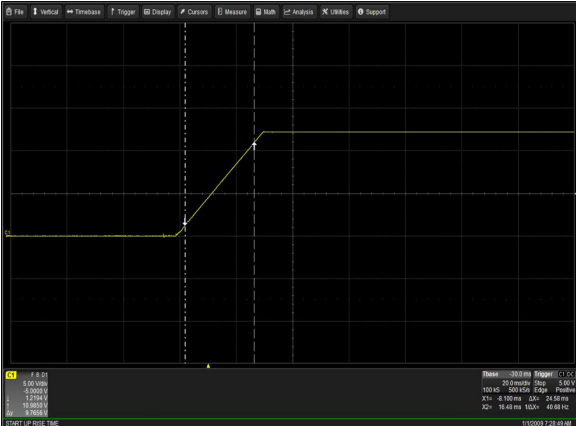

Figure 43: CSU2000AP-3-211 Output Voltage Startup Characteristic
 $V_{in} = 180V_{ac}$ Load: $I_o = 163.9A$ $I_{SB} = 3.5A$
 Ch 1: V_o

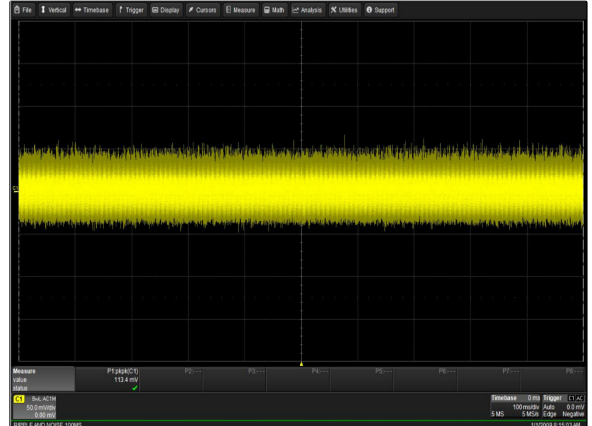

Figure 44: CSU2000AP-3-211 Ripple and Noise Measurement
 $V_{in} = 230V_{ac}$ Load: $I_o = 163.9A$ $I_{SB} = 3.5A$
 Ch 1: V_o

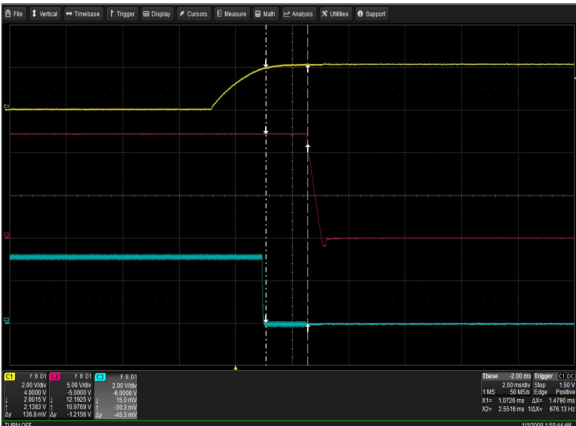

Figure 45: CSU2000AP-3-211 Turn Off Characteristic via PS_ON
 Load: $I_o = 163.9A$ $I_{SB} = 3.5A$
 Ch 1: PS_ON Ch 2: V_o Ch 3: PWOK

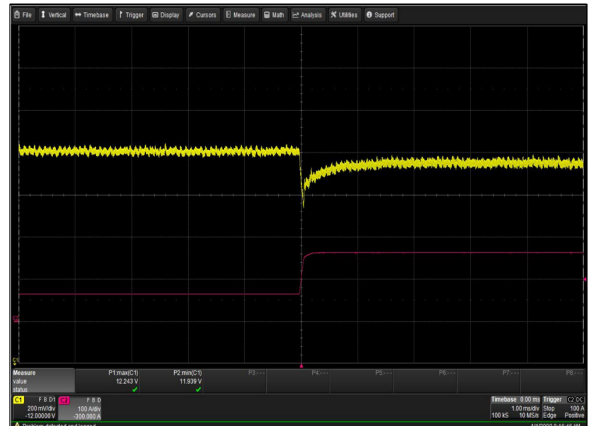

Figure 46: CSU2000AP-3-211 Transient Response - V_o Deviation
 40% to 100% load change 0.5A/ μs slew rate $V_{in} = 230V_{ac}$
 Ch 1: V_o Ch 2: I_o

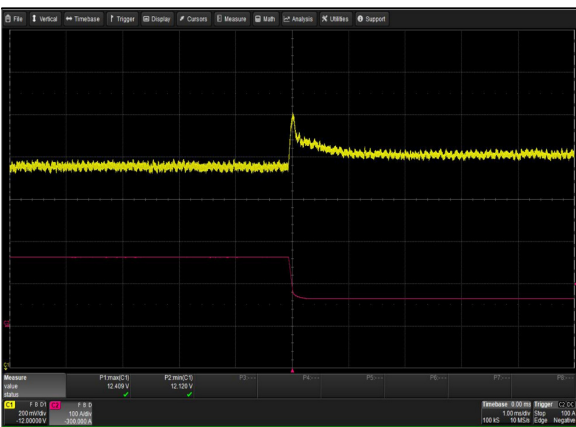

Figure 47: CSU2000AP-3-211 Transient Response - V_o Deviation
 100% to 40% load change 0.5A/ μs slew rate $V_{in} = 230V_{ac}$
 Ch 1: V_o Ch 2: I_o

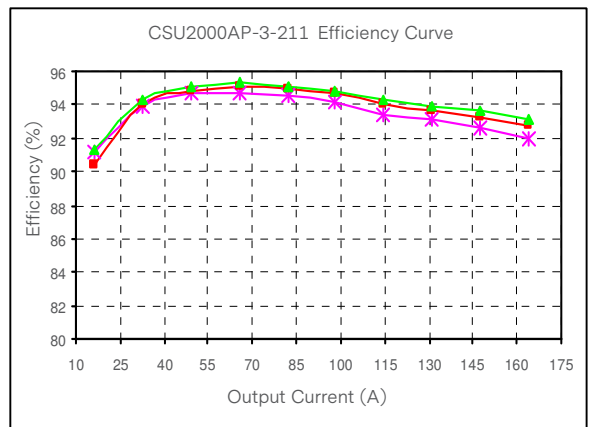

Figure 48: CSU2000AP-3-211 Efficiency Curve @ 25°C
 180Vac 230Vac 264Vac
 Loading: $I_{o,max} = 10\% I_{o,max}$ increment to $I_{o,max}$

ELECTRICAL SPECIFICATIONS

Protection Function Specifications

Input Fuse

CSU2000AP series power supply is equipped with an internal non user serviceable 20A Fast Acting 420Vdc fuse to IEC127 for fault protection on L line input.

Over Voltage Protection (OVP)

The power supply latches off during output overvoltage with the AC line recycling or PSON, PMBus Command to reset the latch. +12V V_{SB} overvoltage protection is also latch mode.

Parameter	Min	Nom	Max	Unit
Main Output Overvoltage	-	-	14.5	V
Standby Output Overvoltage	-	-	14.5	V

Short Circuit Protection (SCP)

The power supply withstands a continuous short circuit with no permanent damage, applied to its main output during start-up or while running. A short is defined as impedance less than 0.04 ohms or less.

When the standby output V_{SB} is shorted the output will go into “hiccup mode”. When the V_{SB} attempts to restart, the maximum peak current from the V_{SB} output will be less than 10.0A.

Over Temperature Protection (OTP)

The power supply is internally protected against over temperature conditions. When the OTP limit is reached, all outputs, except standby, will shutdown and remain off until the over temperature condition no longer exists.

Ambient thermal sensor accuracy is within +/- 3°C.

Model Number	Parameter (Inlet Air Temperature)	Min	Max	Unit
CSU2000AP-3-100 CSU2000AP-3-200	Over Temperature Warning (OTW)	61	/	°C
	Over Temperature Shutdown (OTP)	65.1	/	°C
CSU2000AP-3-111 CSU2000AP-3-211	Over Temperature Warning (OTW)	51	/	°C
	Over Temperature Shutdown (OTP)	55.1	/	°C

ELECTRICAL SPECIFICATIONS

Over Current Protection (OCP)

CSU2000AP series includes internal current limit circuitry to prevent damage in the event of overload or short circuit. It has over current protection (OCP), over current warning (OCW), and over power protection (OPP) limits as defined in table below. They are defined to protect the PSU and to allow peak current to power the system without the PSU shutting down. Fast OCW and slow OCW levels are defined to assert SMBAlert to allow the system to throttle power to protect the PSU and also to allow peak current draws by the system. When OCP trips, it will shutdown and latch off the PSU. The latched PSU is cleared by an AC power cycle or PSON recycle. The power supply can not be damaged from repeated power cycling in this condition. 12V_{SB} is auto-recovered after removing OCP limit.

Vin: High Line

Parameter	Thresholds		Timing		Protection Mode ¹
	Min	Max	Min	Max	
V _O Output Fast Overcurrent Warning	212A	228A	5uS	20uS	SMBAlert
V _O Output Fast Overcurrent Protection	242A	-	0.1mS	-	Foldback then latch after min timing
V _O Output Slow Overcurrent Warning	188A	200A	10mS	15mS	SMBAlert
V _O Output Slow Overcurrent Protection	188A	233A	20mS	0.1S	Shut down and latch only after min - max timing
V _{SB} Output Overcurrent Protection	4.2A	5.0A	10mS	-	Shut down and hiccup mode

Vin: Low Line

Parameter	Thresholds		Timing		Protection Mode ¹
	Min	Max	Min	Max	
V _O Output Fast Overcurrent Warning	140A	156A	5uS	20uS	SMBAlert
V _O Output Fast Overcurrent Protection	152A	-	0.1mS	-	Foldback then latch after min timing
V _O Output Slow Overcurrent Warning	117A	129A	10mS	15mS	SMBAlert
V _O Output Slow Overcurrent Protection	117A	151A	20mS	0.1S	Shut down and latch only after min - max timing
V _{SB} Output Overcurrent Protection	4.2A	5.0A	10mS	-	Shut down and hiccup mode

Note 1 - See diagrams for Fast OCW, Fast OCP and Slow OCW, Slow OCP for SMBAlert and output behaviors.

ELECTRICAL SPECIFICATIONS

Fast OCW, Fast OCP

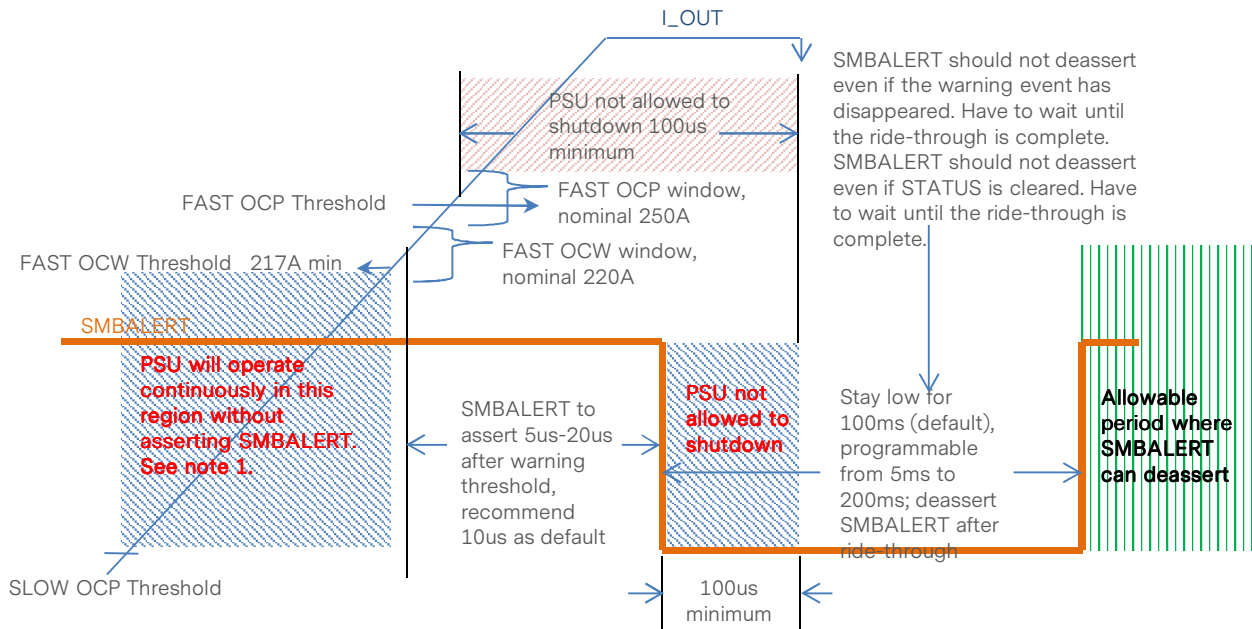

Note 1 - If the duration at 220A exceeds 10ms, the power supply may assert SMBALERT. The minimum time that the power supply must support 220A after SMBALERT asserts is 5ms.

Note 2 - The system must ensure that the average of the pulsed currents do not exceed the DC-max rating of the power supply.

ELECTRICAL SPECIFICATIONS

Thermal Warning, CLST, SLOW OCW, SLOW OCP

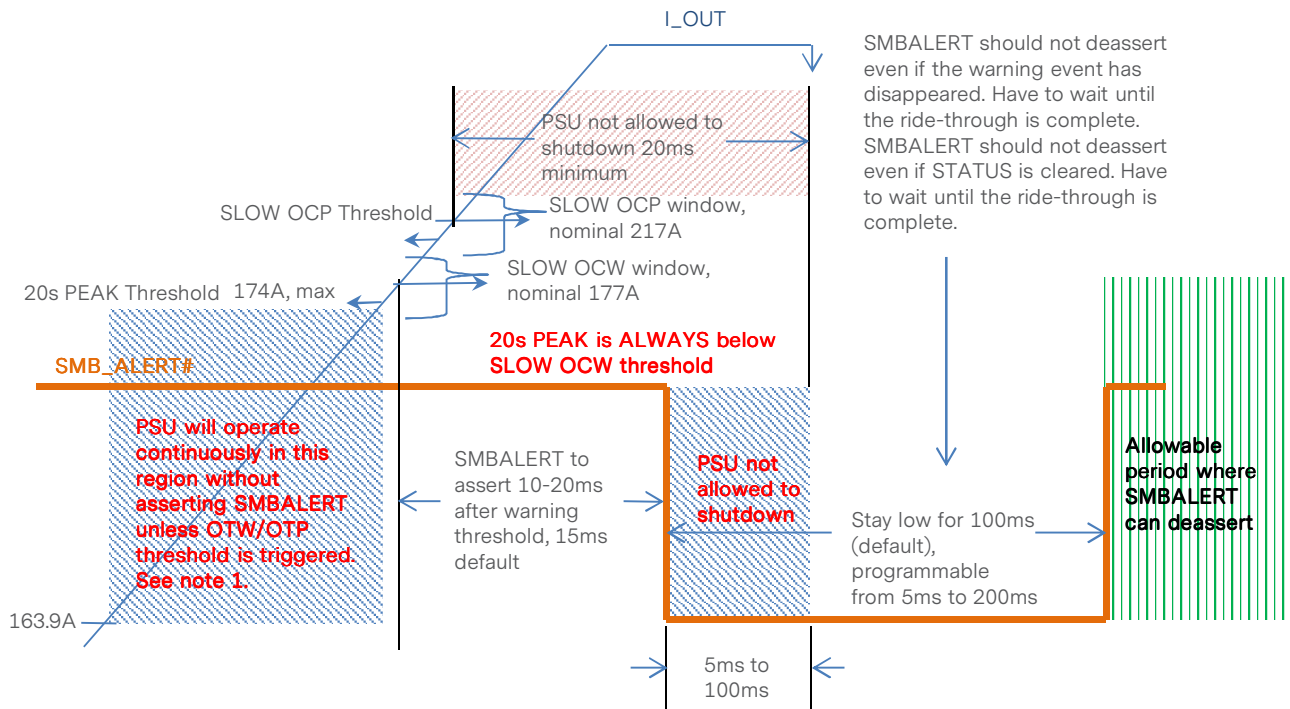

Note 1 - OTW threshold should be set, at the minimum, 4°C below the OTP threshold. OTW asserts SMBALERT, sets STATUS, but does not shutdown the PSU. PSU will shutdown when OTP threshold is triggered.

Note 2 - The system must ensure that the average of the pulsed currents do not exceed the DC-max rating of the power supply.

MECHANICAL SPECIFICATIONS

Mechanical Outlines CSU2000AP-3-100/-111 (unit: mm)

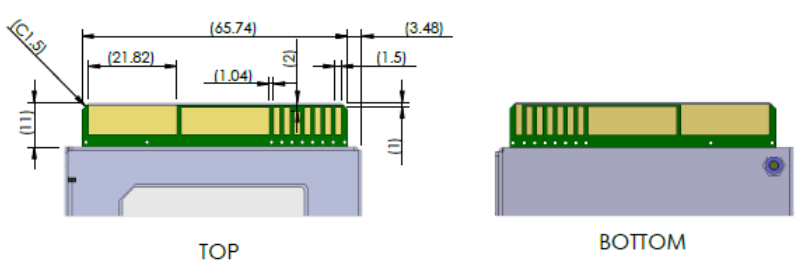
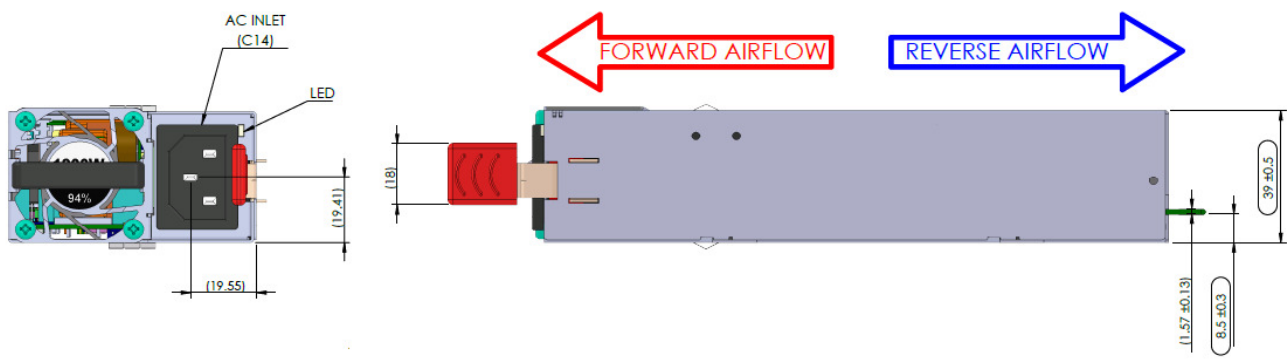
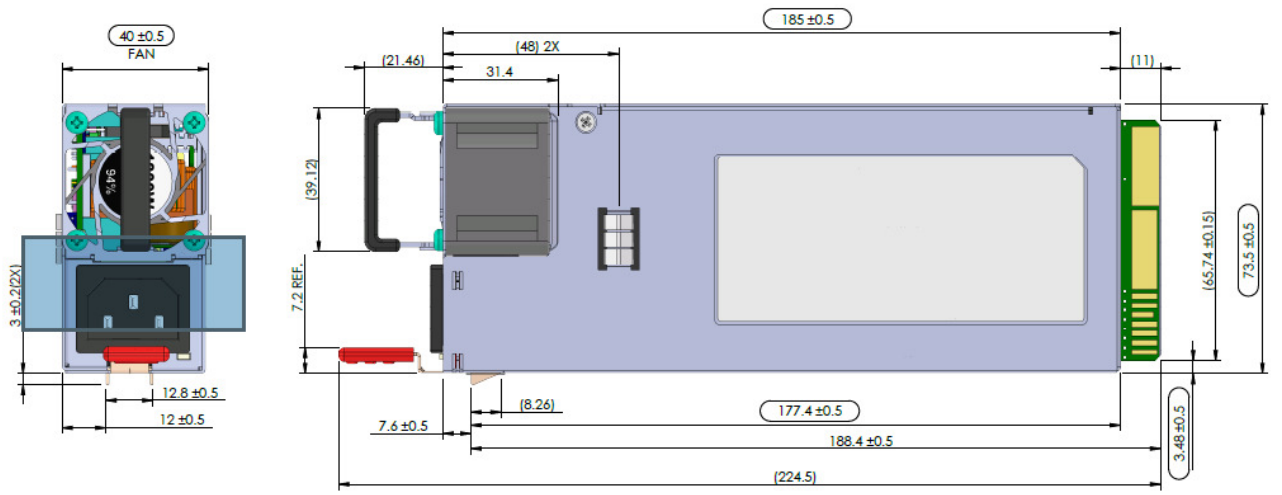

GOLD FINGER REFERENCE

MECHANICAL SPECIFICATIONS

Mechanical Outlines CSU2000AP-3-100/-111 (unit: mm)

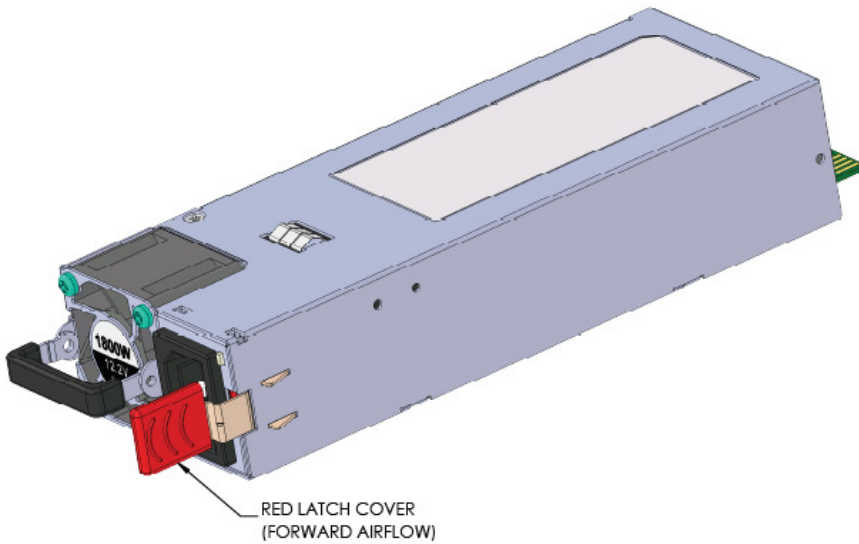
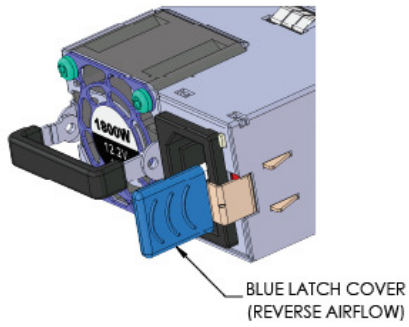

MODEL LIST			
MODEL	AIRFLOW DIRECTION	LATCH COLOR	FAN LABEL
CSU1800AP-3-100	FORWARD	RED	
CSU1800AP-3-111	REVERSE	BLUE	
CSU2000AP-3-100	FORWARD	RED	
CSU2000AP-3-111	REVERSE	BLUE	

Pantone color: Red is 200U/201U. Blue is 278C/279C.

MECHANICAL SPECIFICATIONS

Mechanical Outlines CSU2000AP-3-200/-211 (unit: mm)

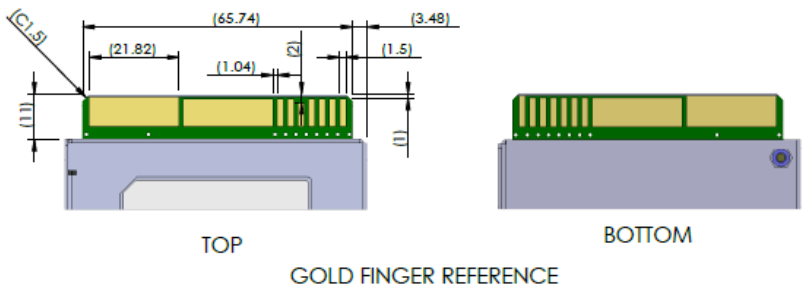
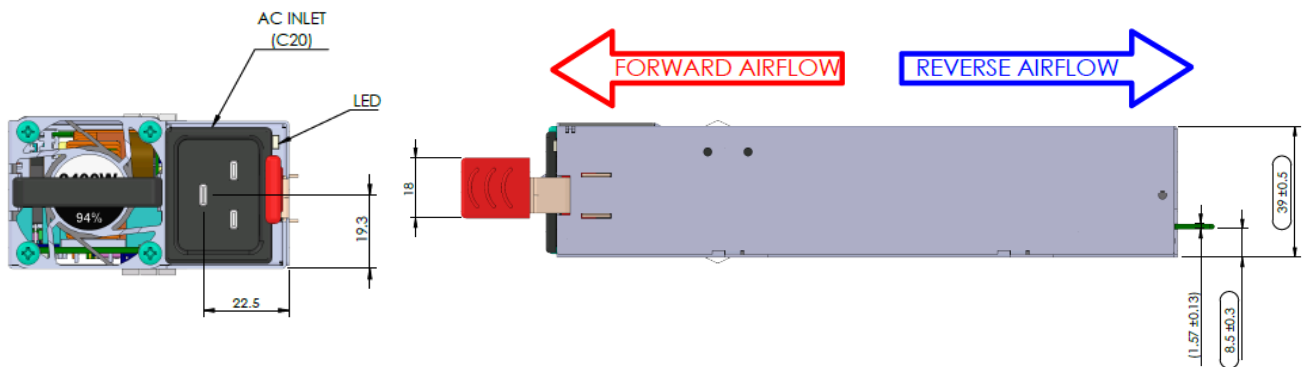
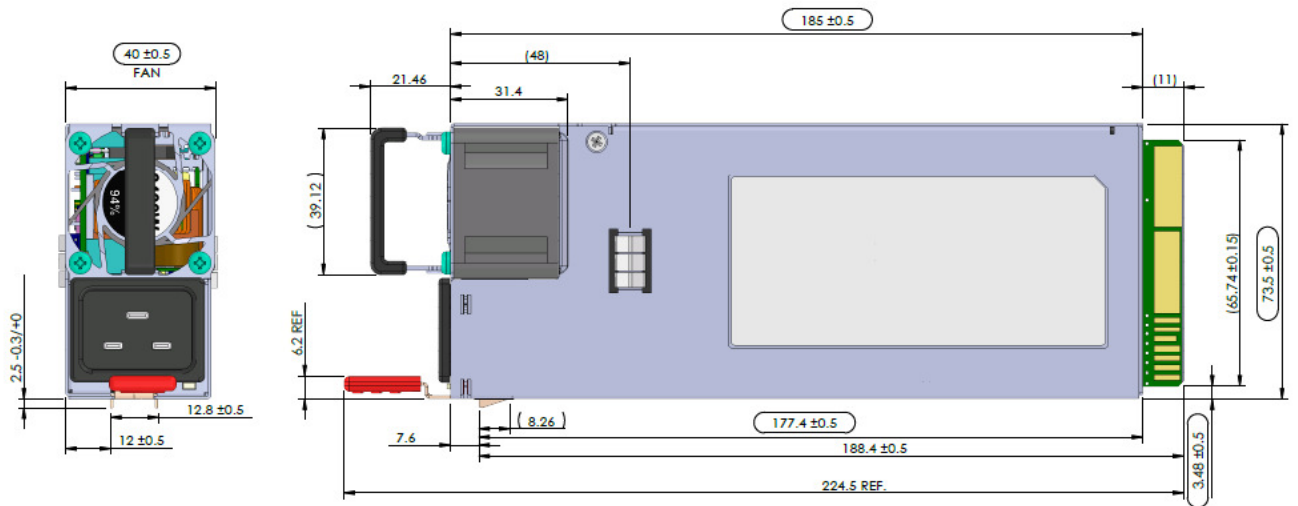

MECHANICAL SPECIFICATIONS

Mechanical Outlines CSU2000AP-3-200/-211 (unit: mm)

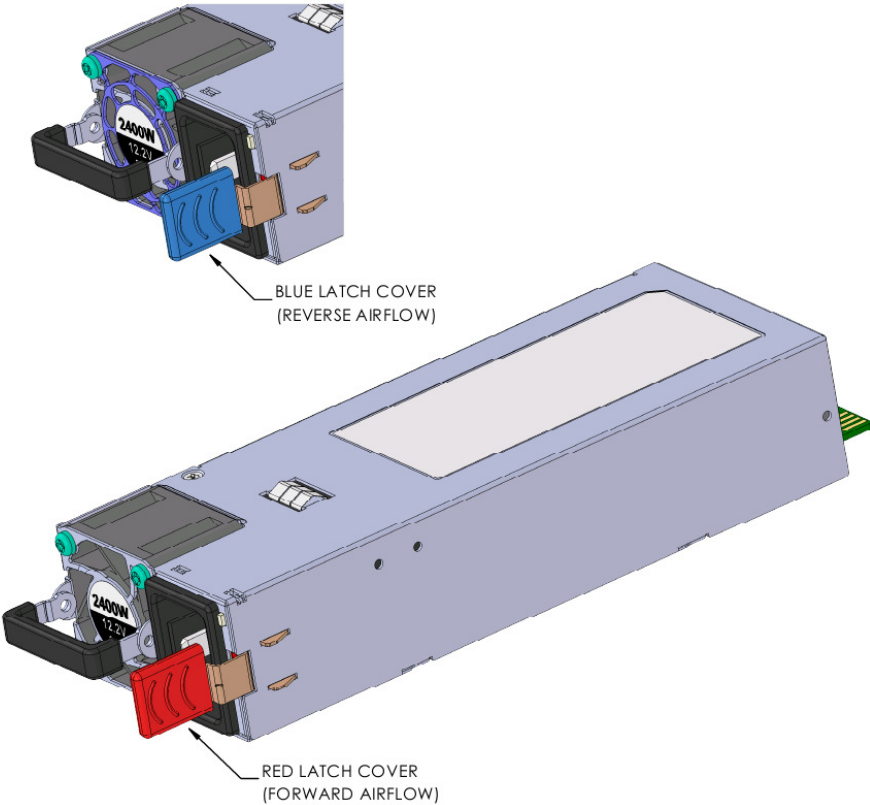

MODEL LIST			
MODEL	AIRFLOW DIRECTION	LATCH COLOR	FAN LABEL
CSU2000AP-3-200	FORWARD	RED	2000W
CSU2000AP-3-211	REVERSE	BLUE	12.2V 94%
CSU2400AP-3-100	FORWARD	RED	2400W
CSU2400AP-3-111	REVERSE	BLUE	12.2V 94%

Pantone color: Red is 200U/201U. Blue is 278C/279C.

MECHANICAL SPECIFICATIONS

Connector Definitions

AC Input Connector

- Pin 1 - Line
- Pin 2 - Neutral
- Pin 3 - Earth Ground

CSU2000AP-3-100/111 C14

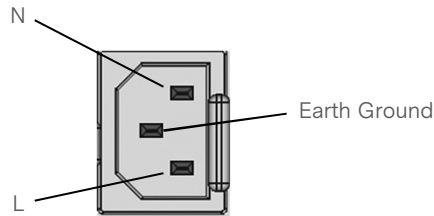

CSU2000AP-3-200/211 C20

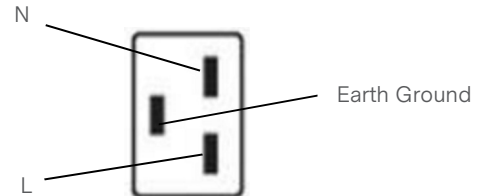

Output Connector - Power Blades

- A1-A9 - Main Output Return
- A10-A18 - Main Output (V_O)
- B1-B9 - Main Output Return
- B10-B18 - Main Output (V_O)

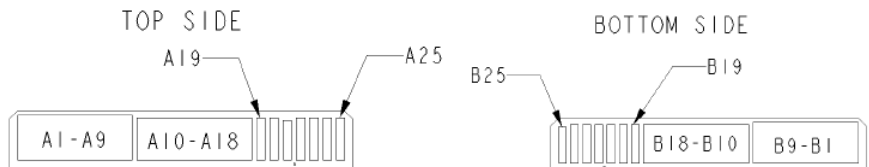

View from power supply output connector end

Output Connector - Control Signals

- A19 - SDA
- A20 - SCL
- A21 - PSON
- A22 - SMBAlert
- A23 - $-V_{SENSE}$
- A24 - $+V_{SENSE}$
- A25 - PWOK
- B19 - A0 (SMBus Address)
- B20 - A1 (SMBus Address)
- B21 - $12V_{SB}$
- B22 - CR_BUS
- B23 - 12V Load Share
- B24 - GND
- B25 - VIN_GOOD

MECHANICAL SPECIFICATIONS

Connector Definitions

AC Input Connector

- Pin 1 - Line
- Pin 2 - Neutral
- Pin 3 - Earth Ground

CSU2000AP-3-100/111 C14

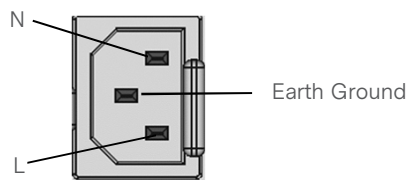

CSU2000AP-3-200/211 C20

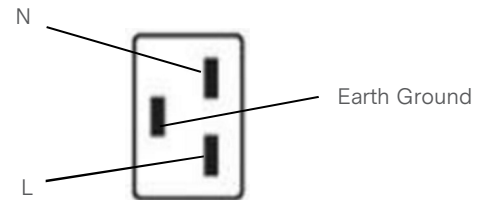

Output Connector - Power Blades

- A1-A9 - Main Output Return
- A10-A18 - Main Output (V_O)
- B1-B9 - Main Output Return
- B10-B18 - Main Output (V_O)

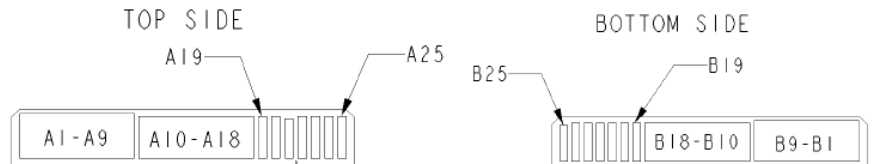

Output Connector - Control Signals

- A19 - SDA
- A20 - SCL
- A21 - PSON
- A22 - SMBAlert
- A23 - $-V_{SENSE}$
- A24 - $+V_{SENSE}$
- A25 - PWOK
- B19 - A0 (SMBus Address)
- B20 - A1 (SMBus Address)
- B21 - $12V_{SB}$
- B22 - CR_BUS
- B23 - 12V Load Share
- B24 - GND
- B25 - VIN_GOOD

View from power supply output connector end

MECHANICAL SPECIFICATIONS

Power / Signal Mating Connectors and Pin Types

Table 5. Mating Connectors for CSU2000AP Series		
Reference	On Power Supply	Mating Connector or Equivalent
AC Input Connector	IEC320-C14 CSU2000AP-3-100/111	IEC320-C13
	IEC320-C20 CSU2000AP-3-200/211	IEC320-C19
Output Connector	Card-edge	Right Angle FCI Amphenol GPCEF4361411HHR FCI Amphenol 10147875-001LF Vertical FCI Amphenol HPG36P14SVP011T

MECHANICAL SPECIFICATIONS

LED Indicator Definitions

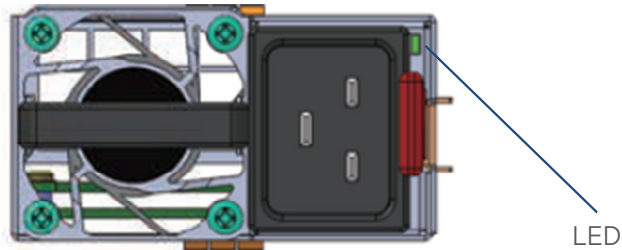

CSU2000AP-3-200/211

One bi-color (green/amber) LED at the power supply front provides the status signal. The status LED conditions are shown on the following table.

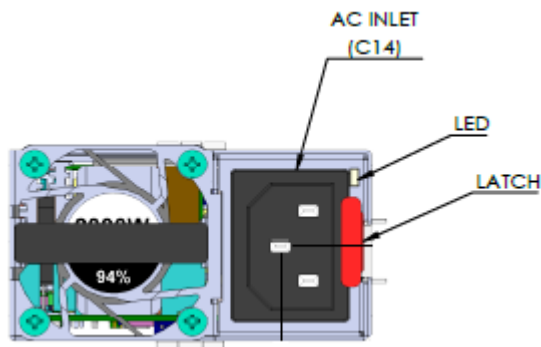

CSU2000AP-3-100/111

Conditions	LED Status
Output ON and OK.	Green
No AC power to all power supplies.	Off
PSU standby state AC present / Only 12V _{SB} on (PS off) / Cold standby state or always standby state as defined in the Cold Redundancy section.	1Hz Blink Green
AC cord unplugged with a second power supply in parallel still with AC input power.	Amber
Power supply critical event causing a shutdown. (Failure, over current, short circuit, over voltage, fan failure, over temperature)	Amber
Power supply warning events where the power supply continues to operate. (High temp, high power, high current, slow fan)	1Hz Blink Amber
Power supply firmware updating.	2Hz Blink Green
Compatibility fault (function disabled if compatibility pin is disabled).	Amber

MECHANICAL SPECIFICATIONS

Weight

The CSU2000AP-3-100/111 series power supply weight is 1002g/2.209lbs.

The CSU2000AP-3-200/211 series power supply weight is 1002g/2.209lbs.

ENVIRONMENTAL SPECIFICATIONS

EMC Immunity

CSU2000AP series power supply is designed to meet the following EMC immunity specifications.

Table 6. Environmental Specifications	
Document	Description
Class A of EN55032 and FCC CFR 47 Part 15 Subpart B	Conducted and Radiated EMI Limits
IEC/EN61000-3-2 GB 17625.1	Harmonics
IEC/EN61000-3-3	Voltage Fluctuations
IEC/EN61000-4-2	Electromagnetic Compatibility (EMC) - Testing and measurement techniques - Electrostatic discharge immunity test: 15KV air, 8KV contact discharge. Performance - Criteria A
IEC/EN61000-4-3	Electromagnetic Compatibility (EMC) - Testing and measurement techniques - Radiated, radio-frequency, electromagnetic field immunity test: 10V/m. Performance - Criteria A
IEC/EN61000-4-4	Electromagnetic Compatibility (EMC) - Testing and measurement techniques - Electrical fast transient/burst immunity test: +/-2KV for AC power port. Performance - Criteria A
IEC/EN61000-4-5 GR1089	Electromagnetic Compatibility (EMC) - Testing and measurement techniques - Surge test: +/-2KV common mode and +/-1KV differential mode for AC ports. Performance - Criteria A
IEC/EN61000-4-6	Electromagnetic Compatibility (EMC) - Testing and measurement techniques - Conducted Immunity 10Vrms. Performance - Criteria A.
EN61000-4-11	Electromagnetic Compatibility (EMC) - Testing and measurement techniques - Voltage dips and interruptions: Criteria A: >95% reduction for 10ms; Criteria B: 30% reduction for 500mS, or Criteria C (self-recoverable only) >95% reduction for 500mS.
IEC61000-4-12	Ring wave, 2KV common mode and 1KV differential mode. Performance - Criteria A.

Notes: Performance Criteria as defined by EN300386.

Performance Criteria A: The apparatus shall continue to operate as intended after the test. No degradation of performance or loss of function is allowed below specified performance level during intended use of operation.

Performance Criteria B: The apparatus shall continue to operate as intended after the test. No degradation of performance or loss of function is allowed below specified performance level during intended use of operation. Degradation of performance is allowed during the exposure to an electromagnetic phenomenon but no change of actual operating state is allowed.

Performance Criteria C: Temporary loss of function is allowed, provided the function is self-recoverable or can be restored by the operation of the controls.

ENVIRONMENTAL SPECIFICATIONS

Safety Certifications

The CSU2000AP series power supply is intended for inclusion in other equipment and the installer must ensure that it is in compliance with all the requirements of the end application. This product is only for inclusion by professional installers within other equipment and must not be operated as a stand alone product.

Table 7. Safety Certifications for CSU2000AP Series Power Supply		
Standard	Agency	Description
UL60950-1, CAN/CSA C22.2 No.60950-1	UL + CUL	US and Canada Requirements
IEC and EN60950/62368	CE	European Requirements
UL62368-1:2014, CAN/CSA C22.2 No.62368-1:2014	UL + CUL	US and Canada Requirements
CB Certificate and Report		All CENELEC Countries
CHINA CCC or CQC Approval		China Requirements
KC		Korea Certification
EAC		Russia Requirements
BIS		India Requirements
BSMI		Taiwan Requirements
CE		LVD, ROHS, EMC

ENVIRONMENTAL SPECIFICATIONS

EMI Emissions

The CSU2000AP series power supply has been designed to comply with the Class A limits of EMI requirements of FCC CFR 47 Part 15 Subpart B and EN55032 for emissions and relevant sections of EN55032: 2011 for immunity. The unit is tested at 2000W using resistive load with cooling fan.

Conducted Emissions

The applicable standard for conducted emissions is EN55032 (FCC Part 15). Conducted noise can appear as both differential mode and common mode noise currents. Differential mode noise is measured between the two input lines, with the major components occurring at the supply fundamental switching frequency and its harmonics. Common mode noise, a contributor to both radiated emissions and input conducted emissions, is measured between the input lines and system ground and can be broadband in nature.

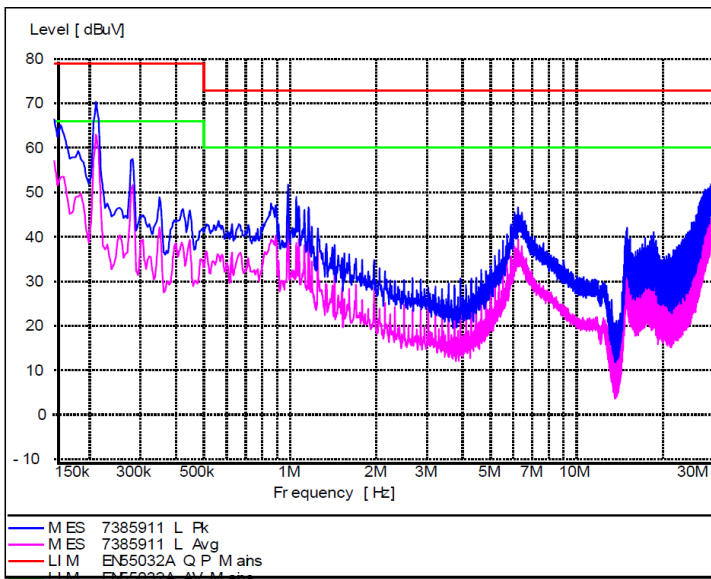

The CSU2000AP series power supply has internal EMI filters to ensure the convertor’s conducted EMI levels comply with EN55032 (FCC Part 15) Class A limits. The EMI measurements are performed with resistive loads at maximum rated loading.

Sample of EN55032 conducted EMI measurement at 110Vac input.

Note: Red Line refers to Artesyn Quasi Peak margin, which is 6dB below the CISPR international limit. Pink Line refers to the Artesyn Average margin, which is 6dB below the CISPR international limit.

Conducted EMI emissions specifications of the CSU2000AP series power supply:

Parameter	Model	Symbol	Min	Typ	Max	Unit
FCC Part 15, class A	All	Margin	-	6	-	dB
CISPR 32 (EN55032), class A	All	Margin	-	6	-	dB

ENVIRONMENTAL SPECIFICATIONS

Radiated Emissions

Unlike conducted EMI, radiated EMI performance in a system environment may differ drastically from that in a stand-alone power supply. The shielding effect provided by the system enclosure may bring the EMI level from Class A to Class B. It is thus recommended that radiated EMI be evaluated in a system environment. The applicable standard is EN55032 Class A (FCC Part 15). Testing AC-DC converters as a stand-alone component to the exact requirements of EN55032 can be difficult because the standard calls for 1m lead to be attached to the input and outputs and aligned such as to maximize the disturbance. In such a set-up, it is possible to form a perfect dipole antenna that very few AC-DC converters could pass. However, the standard also states that an attempt will be made to maximize the disturbance consistent with the typical application by varying the configuration of the test sample.

ENVIRONMENTAL SPECIFICATIONS

Operating Temperature

The CSU2000AP series power supply starts and operates with full rated power at an ambient temperature from -5°C to 55°C. Allowable up to 65°C at 60% load.

Table 8. Operating Temperature Requirements (Air Inlet Temperature)				
Model	Output Power	Altitude	Operating Temperature	
			Min	Max
CSU2000AP-3-100 CSU2000AP-3-200 ¹	Low line: 1400W High line: 2000W	950m	-5°C	55°C ³
	Low line: 840W High line: 1200W	3050m	-5°C	65°C ²
	Low line: 980W High line: 1400W	Sea level	-5°C	65°C ²
	Low line: 1260W High line: 1800W	5000m	-5°C	35°C ²
CSU2000AP-3-111 CSU2000AP-3-211 ¹	Low line: 1400W High line: 2000W	1000m	-5°C	40°C
	Low line: 840W High line: 1200W	3050m	-5°C	50°C ²
	Low line: 980W High line: 1400W	Sea level	-5°C	55°C ²
	Low line: 1400W High line: 2000W	5000m	-5°C	35°C ²

Note 1 - High line input only.
 Note 2 - Safe operating point where components are within thermal rating.
 Note 3 - Specified operating condition.

Thermal Derating Curve

Forward Airflow: Output power derated linearly from 100% to 60% when operating from 55°C to 65°C.
 Reverse Airflow: Output power derated linearly from 100% to 60% when operating from 40°C to 50°C.

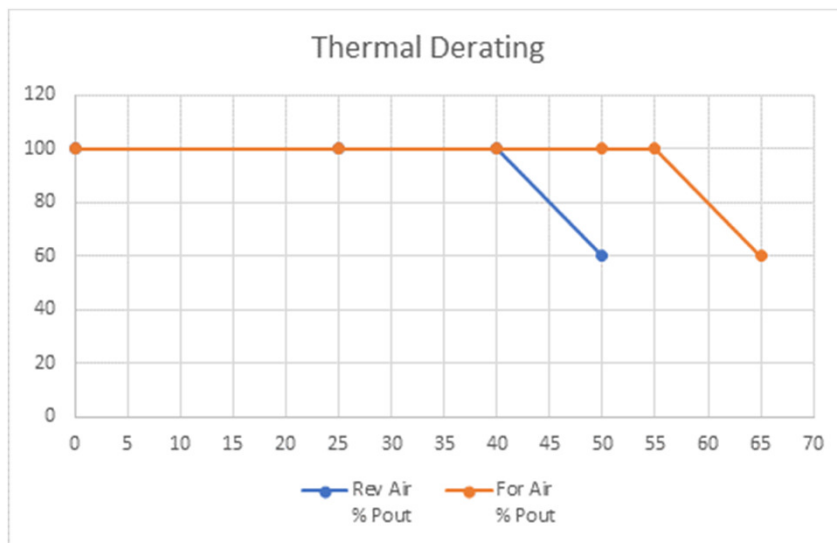

ENVIRONMENTAL SPECIFICATIONS

Forced Air Cooling

The CSU2000AP series includes internal cooling fans as part of the power supply assembly to provide forced air-cooling to maintain and control temperature of devices and ambient temperature in the power supply to appropriate levels. The standard direction of airflow is from the DC connector end to the AC connector end of the power supply. The power supply must meet thermal requirements at according Table 7.

PQ Curve

The CSU2000AP series power supply pressure vs airflow curve is shown in the below figure.

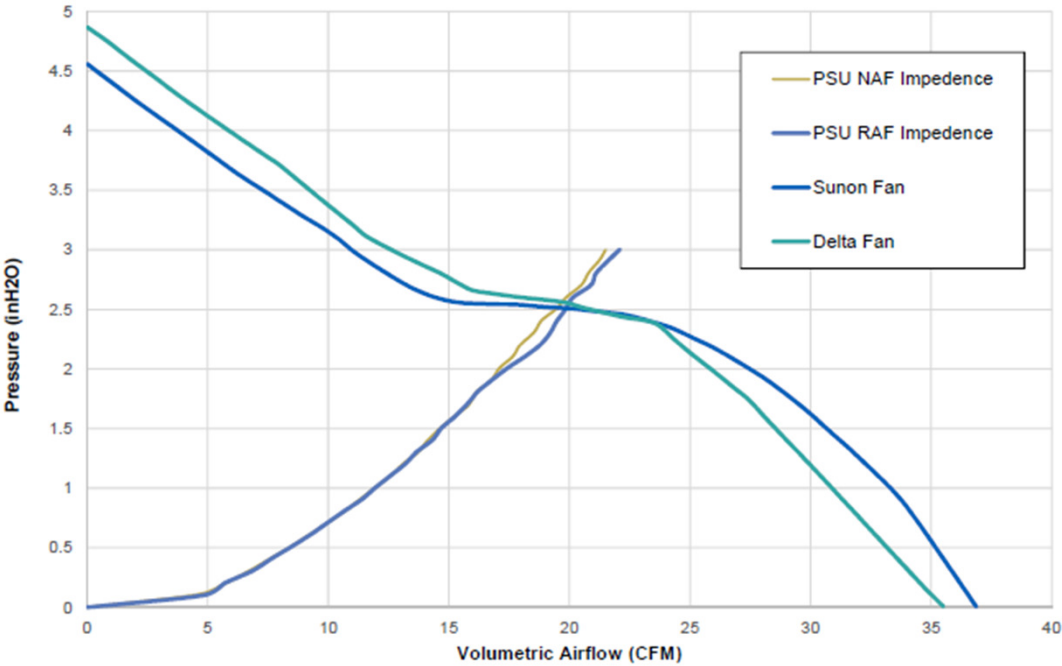

ENVIRONMENTAL SPECIFICATIONS

Storage and Shipping Temperature

The CSU2000AP series power supply can be stored or shipped at temperatures between -40°C to +70°C and relative humidity from 5% to 95% non-condensing.

Altitude

The CSU2000AP series power supply is certified for safety spacing's requires for 5000 meters altitude. The power supply will not be damaged when stored at altitudes of up to 15200 meters above sea level.

Humidity

The CSU2000AP series power supply can operate within specifications when subjected to a relative humidity from 5% to 95% non-condensing. The power supply can be stored in a relative humidity from 5% to 95% non-condensing.

Vibration

The CSU2000AP series power supply will pass the following vibration specifications:

Non-Operating Random Vibration

Acceleration	3.13	gRMS	
Frequency Range	5 - 500	Hz	
Duration	15	Mins	
Direction	3 mutually perpendicular axis		
PSD Profile	FREQ (Hz)	SLOPE (db/oct)	PSD (g ² /Hz)
	5	/	0.01
	20	/	0.02
	20 - 500	/	0.02

Operating Random Vibration

Acceleration	0.15	gRMS	
Frequency Range	5 - 500	Hz	
Duration	30	Mins	
Direction	3 mutually perpendicular axis		
PSD Profile	FREQ (Hz)	SLOPE (db/oct)	PSD (g ² /Hz)
	5 - 50	/	0.002
	50 - 100	/	0.04

ENVIRONMENTAL SPECIFICATIONS

Shock

The CSU2000AP series power supply will pass the following shock specifications:

Non-Operating Half-Sine Shock

Acceleration	50	G
Duration	170	in. / sec
Pulse	Trapezoidal wave	
Number of Shock	3 shocks in each of 6 faces	

Operating Half-Sine Shock

Acceleration	20	G
Duration	10	mSec
Pulse	Half-Sine	
Number of Shock	3 shocks in each of 6 faces	

POWER AND CONTROL SIGNAL DESCRIPTIONS

AC Input Connector

This connector supplies the AC mains to the CSU2000AP series power supply.

- Pin 1 – L
- Pin 2 – N
- Pin 3 – Earth Ground

Output Connector – Power Blades

These pins provide the main output for the CSU2000AP series power supply. The main output (V_O) and the main output return pins are the positive and negative rails, respectively, of the V_O main output of the CSU2000AP series power supply. The main output (V_O) is electrically isolated from the power supply chassis.

- A1-A9 – Main Output Return
- A10-A18 – Main Output (V_O)
- B1-B9 – Main Output Return
- B10-B18 – Main Output (V_O)

Output Connector – Control Signals

The CSU2000AP series power supply contains a 14 pins control signal header providing an analogue control interface, standby power and I²C interface signal connections.

SDA, SCL, A0, A1 - (Pins A19, A20, B19, B20)

Please refer to “Communication Bus Descriptions” section on page 35.

PSON - (Pin A21)

This signal input pin controls the normal turn on and off of the main output of the CSU2000AP series power supply. The power supply main output (V_O) will be enabled when this signal is pulled low below 0.8V. The power supply output (except V_{SB} output) will be disabled when this input is driven higher than 2.0V. This signal can be pulled high to 5V maximum. The PSU has a 10K internal pull-up resistor, hence no additional pull-up resistor required by system. The source current is 4mA maximum when V_{pson} is low.

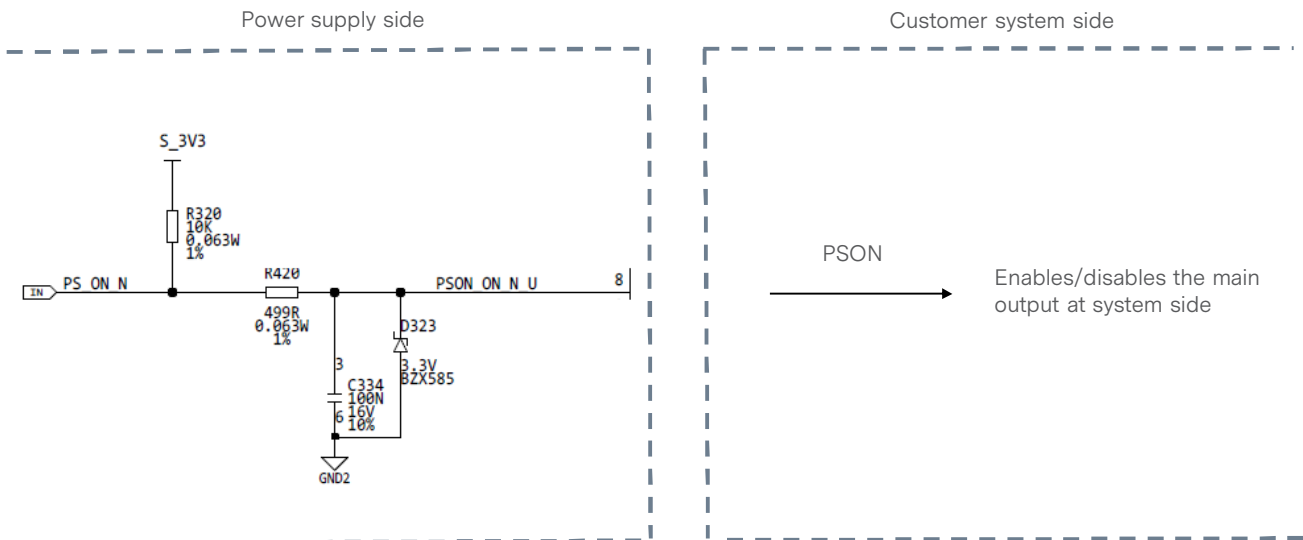

POWER AND CONTROL SIGNAL DESCRIPTIONS

SMBALERT - (Pin A22)

SMBALERT is an active low signal used to send an interrupt to the system that a warning or critical event in the PSU occurred. The pin is normally high. It is asserted (goes low) when a warning or fault occurred. The conditions where in the signal is de-asserted (goes back to high) are AC recycle, PSON recycle and issuance of a CLEAR_FAULTS PMBus™ command. The power supply will assert the SMBALERT <4ms after AC input voltage is lost to 0Vac.

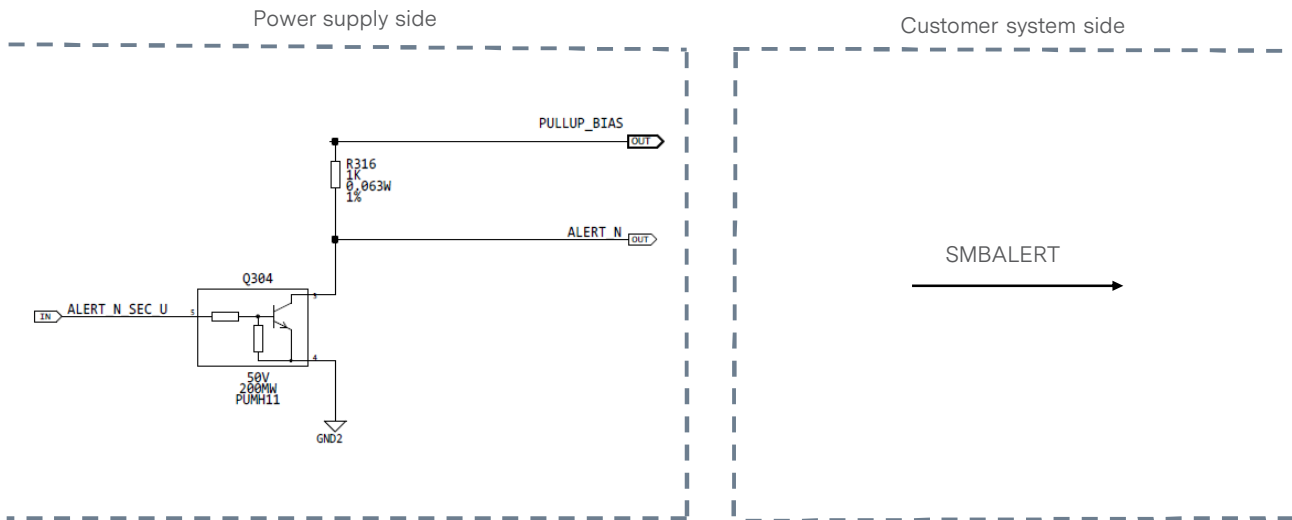

+VSENSE & -VSENSE - (Pins A23, A24)

This remote sense circuit will be designed to compensate for a power path drop around the entire loop of 0.1V. These pins should be connected as close to the loading as possible. If left open, the remote sense will not work properly and the voltage level of main output will go lower than the guaranteed spec.

PWOK - (Pin A25)

The PWOK is an output signal driven high above 2.0V by the power supply to indicate that all outputs are valid. If any of the power supply outputs fails below its regulation limits, this signal will be driven low below 0.4V. The sink current is 0.4mA maximum when the signal is low and is 2mA maximum when the signal is high. The rise time and fall time of the signal is 100uS maximum. If the AC power is lost, this signal must be driven low at least 20ms before the standby output goes below regulation range. This signal has 1K pull-up resistor connected to standby bus before oring device inside PSU.

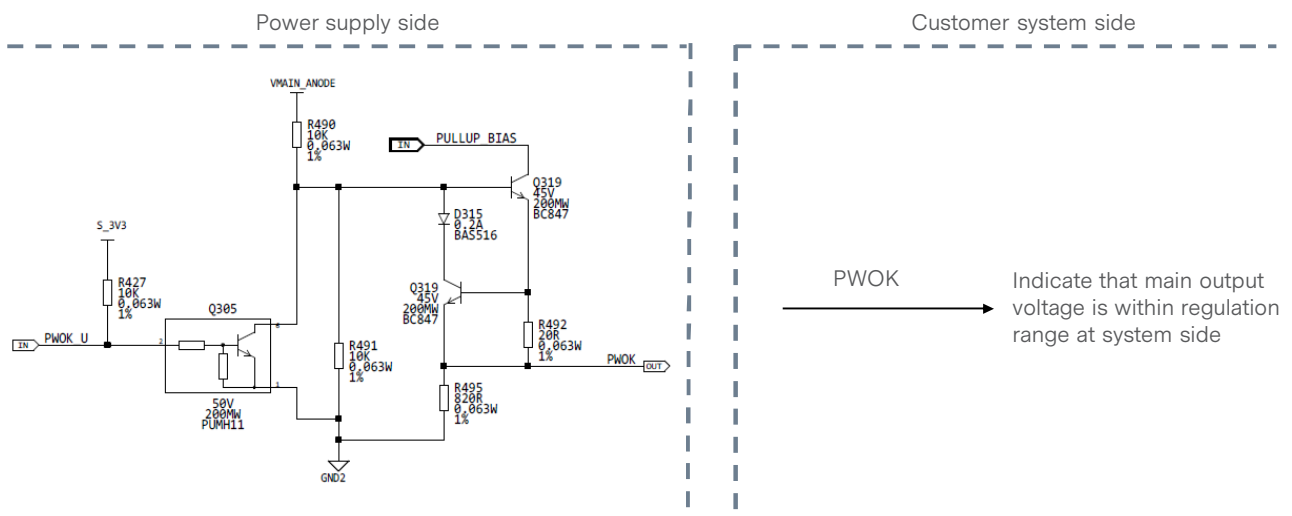

POWER AND CONTROL SIGNAL DESCRIPTIONS

CR_BUS - (Pin B22)

There is an additional signal defined supporting cold redundancy. This is connected to a bus shared between the power supplies and CR_BUS. This is a tri-state output signal of the power supply used to communicate a fault or Vout under-voltage level has occurred in one of the power supplies. This is used to power on all the power supplies in the system via the CR_BUS. When the signal is pulled high, it allows all power supplies in cold standby mode to go into cold standby state when the load share voltage is below the VCR_ON level. When the signal is left open on all power supplies, it forces all cold standby power supplies into the ON. The cold redundancy section showing the logic state of the CR_BUS signal depending upon the programmed configuration of the power supply in D0h, the operating state of the power supply, and the power supply fault status.

Refer cold redundancy part for details.

12V Load Share - (Pin B23)

12V load share is a single wire bus signal used to help equalize the output current from two or more power supplies connected to a common load. The current share signal is a DC signal that represents the load current that a power supply is providing. This voltage increases proportionately with the output load. The expected voltage levels are stated as below table.

ISHARE signal voltage of the CSU2000AP series power supply:

Load (per power supply unit)	Model	Min	Nom	Max	Unit
100%I _{O,max}	All	7.6	8.0	8.4	Vdc
50%I _{O,max}	All	3.8	4.0	4.2	Vdc

GND (Used by system for presence detect) - (Pin B24)

This signal used to indicate to the system that a power supply is inserted in the power bay. This pin is grounded inside the power supply. Recommended pull-up resistor to 12Vsb is 8.2k ohm with a 3.0k ohm pull-down to ground. A 100pF decoupling capacitor is also recommended.

- Low - PS is present.
- High - PS is removed from system.

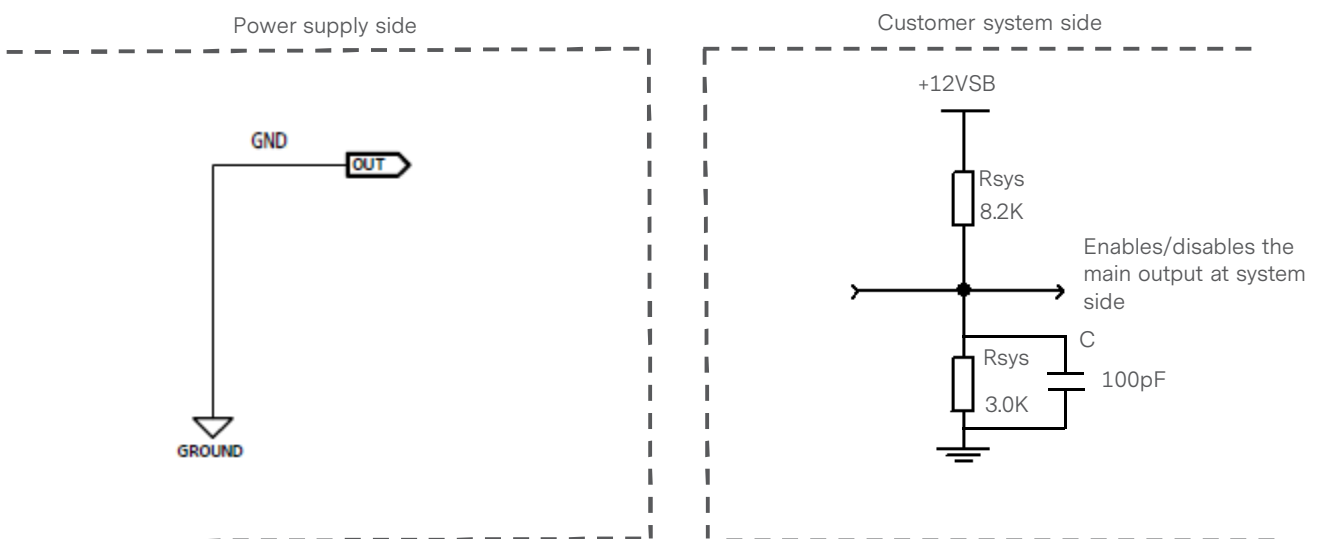

POWER AND CONTROL SIGNAL DESCRIPTIONS

VIN_GOOD - (Pin B25)

When B25 is used as VIN_GOOD, this signal will be asserted, driven HIGH (>2.0V) by the power supply to indicate that the input applied is within the valid range. If the input power is lost to 0V, this signal must be driven low. The sink current is 0.4mA maximum when the signal is low and is 2mA maximum when the signal is high. The rise time and fall time of the signal is 100uS maximum.

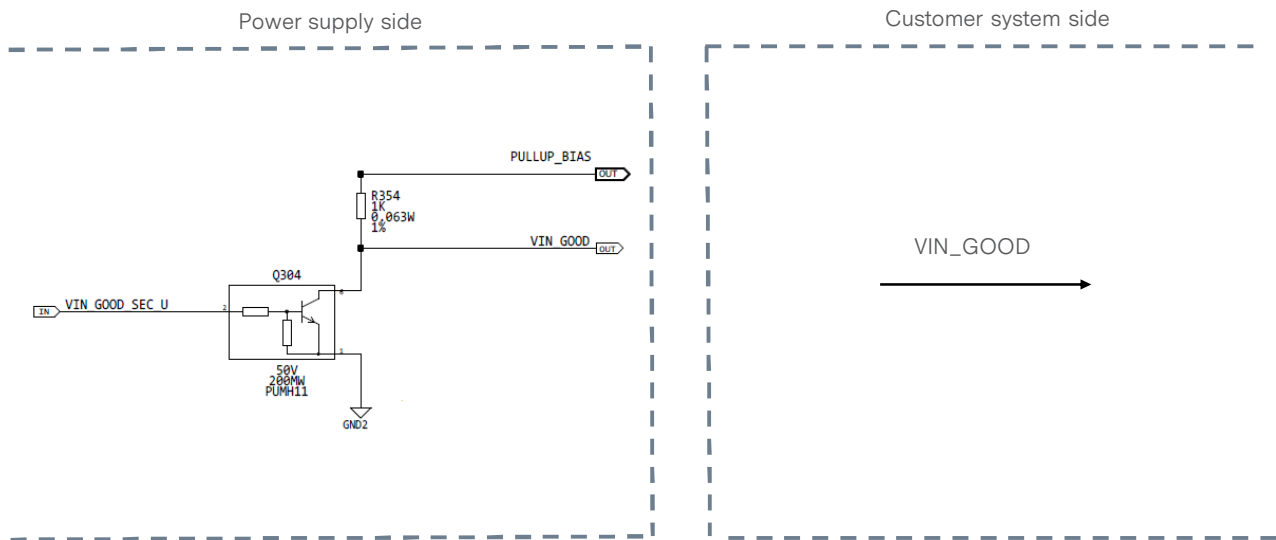

COMMUNICATION BUS DESCRIPTIONS

I²C Bus Signals

CSU2000AP series power supply contains enhanced monitor and control functions implemented via the I²C bus. The CSU2000AP series I²C functionality (PMBus™ and FRU data) can be accessed via the output connector control signals. The communication bus is powered either by the internal 3.3V supply or from an external power source connected to the standby output (i.e. accessing an unpowered power supply as long as the standby output of another power supply connected in parallel is on).

If units are connected in parallel or in redundant mode, the standby outputs must be connected together in the system. Otherwise, the I²C bus will not work properly when a unit is inserted into the system without the DC source connected.

Note: PMBus™ functionality can be accessed only when the PSU is powered-up. Guaranteed communication I²C speed is 100KHz.

A0, A1 (I²C Address Signals) - (Pins B19, B20)

These input pins are the address lines A0 and A1 to indicate the slot position the power supply occupies in the power bay and define the power supply addresses for FRU data and PMBus™ data communication. This allows the system to assign different addresses for each power supply. During I²C communication between the system and power supplies, the system will be the master and the power supplies will be the slave. They are internally pulled up to internal 3.3V supply.

SDA, SCL (I²C Data and Clock Signals) - (Pins A19, A20)

I²C serial data and clock bus - these pins must be pulled-up by a 2.2Kohm resistor to 3.3V at the system side.

I²C Bus Communication Interval

The interval between two consecutive I²C communications to the power supply must be at least 15ms to ensure proper monitoring functionality.

I²C Bus Signal Integrity

The noise on the I²C bus (SDA, SCL lines) due to the power supply will be less than 300mV peak-to-peak. This noise measurement should be made with an oscilloscope bandwidth limited to 100MHz. Measurements must be made at the power supply output connector with 10Kohm resistors pulled up to 3.3V source and a decoupling 47pF ceramic capacitors to standby output return.

COMMUNICATION BUS DESCRIPTIONS

I²C Bus Internal Implementation, Pull-ups and Bus Capacitances

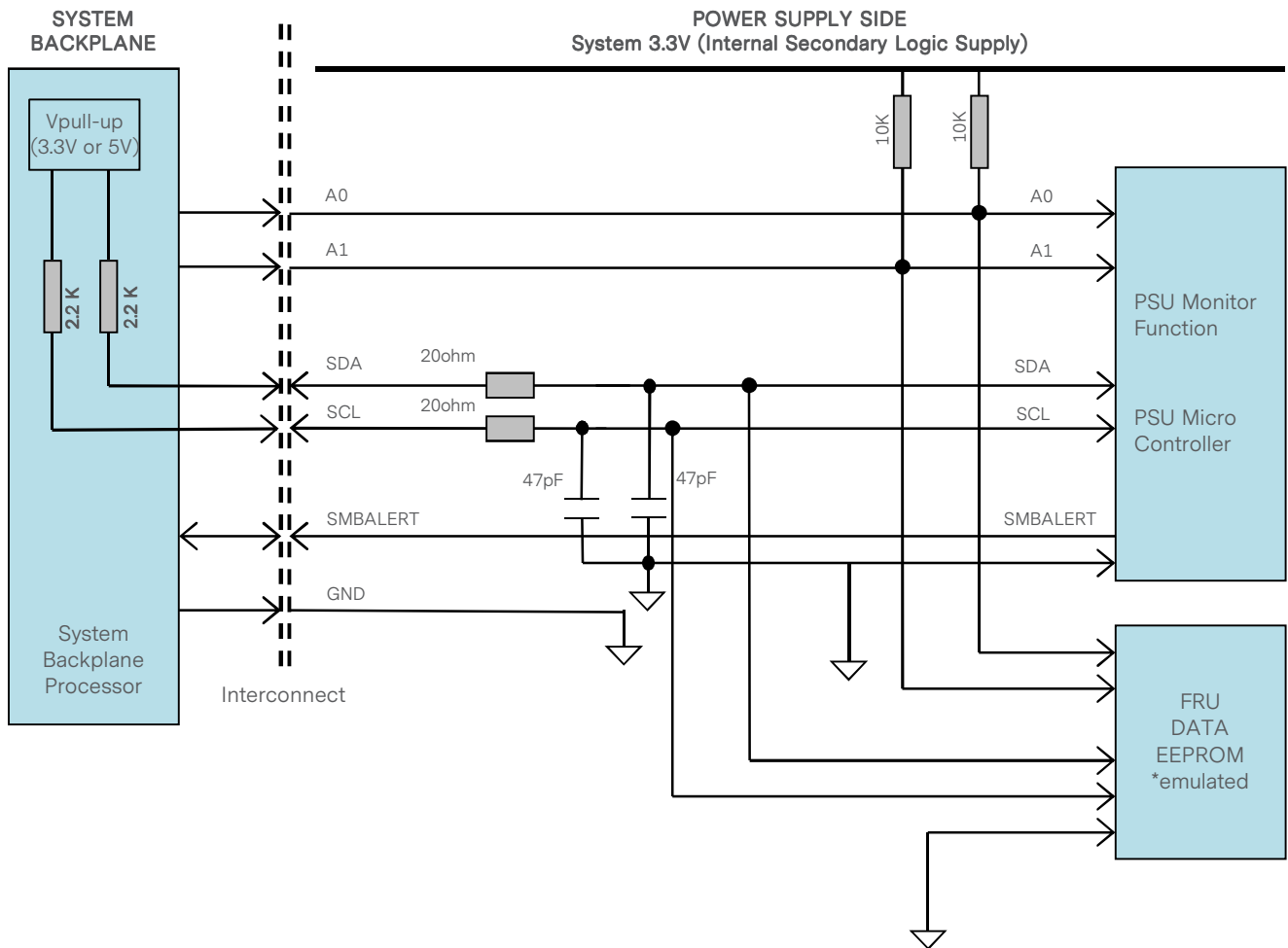

I²C Bus - Recommended external pull-ups

Electrical and interface specifications of I²C signals (referenced to standby output return pin, unless otherwise indicated):

Parameter	Condition	Symbol	Min	Type	Max	Unit
SDA, SCL Internal Pull-up Resistor		R _{int}	-	-	-	Kohm
SDA, SCL Internal Bus Capacitance		C _{int}	-	47	-	pF
Recommended External Pull-up Resistor	1 to 4 PSU	R _{ext}	1	2.2	3	Kohm
Recommended External Pull-up Voltage		V _{pull-up}	3.3	-	5	V

COMMUNICATION BUS DESCRIPTIONS

Logic Levels

CSU2000AP series power supply I²C communication bus will respond to logic levels as per below:

Logic High: 3.3V nominal (Spec is 2.1V to 5.5V)**

Logic Low: 500mV nominal (Spec is 800mV max)**

**Note: Artesyn 73-769-001 I²C adapter was used.

Timings

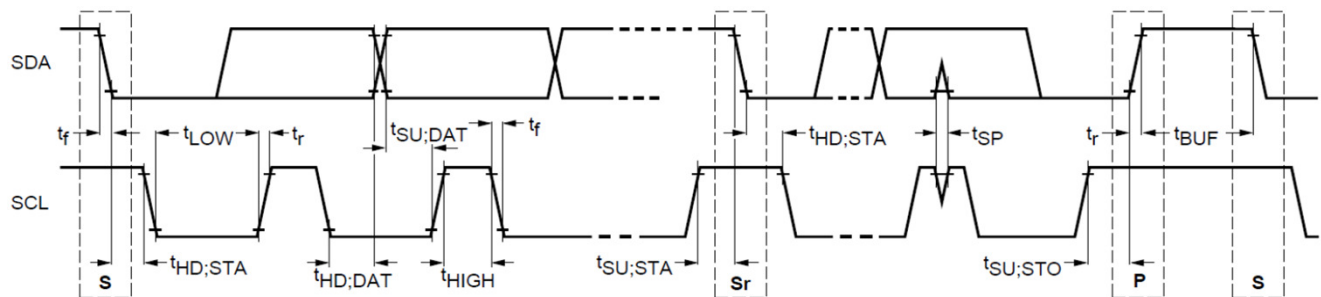

Parameter	Symbol	Standard-Mode Specs		Actual Measured	Unit
		Min	Max		
SCL clock frequency	f_{SCL}	0	100	98	KHz
Hold time (repeated) START condition	$t_{HD;STA}$	4.0	-	5	uS
LOW period of SCL clock	t_{LOW}	4.7	-	5.2	uS
HIGH period of SCL clock	t_{HIGH}	4.0	-	4.8	uS
Setup time for repeated START condition	$t_{SU;STA}$	4.7	-	5.4	uS
Data hold time	$t_{HD;DAT}$	0	3.65	0.6	uS
Data setup time	$t_{SU;DAT}$	250	-	4200	nS
Rise time	t_r	-	1000	SCL = 669.6 SDA = 710.4	nS
Fall time	t_f	-	300	SCL = 156.8 SDA = 146	nS
Setup time for STOP condition	$t_{SU;STO}$	4.0	-	5.02	uS
Bus free time between a STOP and START condition	t_{BUF}	4.7	-	95***	uS

***Note: Artesyn 73-769-001 I²C adapter (USB-to-I2C) and Universal PMBus™ GUI software was used.

COMMUNICATION BUS DESCRIPTIONS

Device Addressing

The CSU2000AP series power supply will respond to supported commands on the I²C bus that are addressed according to A1 and A0 pins of output connector.

Address pins are held HIGH by default via pulled up to internal 3.3V supply. To set the address as “0”, the corresponding address line needs be pulled down to logic ground level. Below tables show the address of the power supply with A0 and A1 pins set to either “0” or “1”.

PSU Slot	Slot ID Bits		PMBus™ Address	EEPROM (FRU) Read Address
	A1	A0		
1	0	0	0xB0	0xA0
2	0	1	0xB2	0xA2
3	1	0	0xB4	0xA4
4	1	1	0xB6	0xA6

COMMUNICATION BUS DESCRIPTIONS

I²C Clock Synchronization

The CSU2000AP-3 series power supply applies clock stretching. An addressed slave power supply holds the clock line (SCL) low after receiving (or sending) a byte, indicating that it is not yet ready to process more data. The system master that is communicating with the power supply will attempt to raise the clock to transfer the next bit but must verify that the clock line was actually raised. If the power supply is clock stretching, the clock line will still be low (because the connections are open-drain).

The maximum time-out condition for clock stretching for CSU2000AP series is 30 milliseconds.

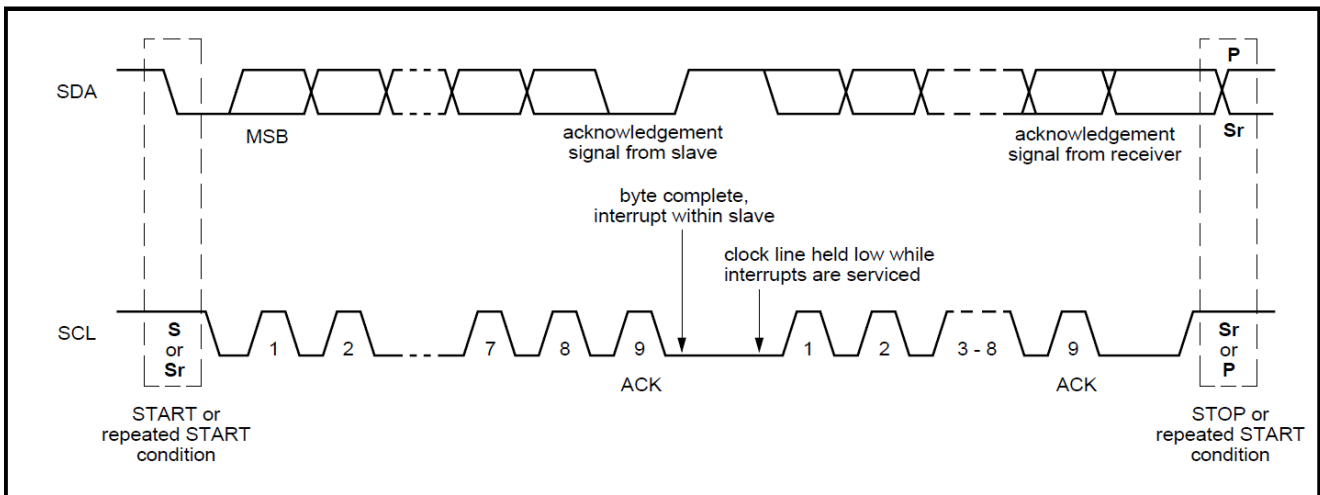

COMMUNICATION BUS DESCRIPTIONS

Cold Redundancy

The CSU2000AP series power supply supports capabilities for cold redundancy. This capability helps improve the efficiency and iTHD of the power subsystem when more than one power supply is used in a system. Cold redundancy uses the PMBus™ manufacturer specific command area to define commands for the system to configure the power supplies for cold redundancy.

Overview

A system in 1+1, 2+1, 3+1 or 2+2 redundant mode configuration may not be operated at the optimum efficiency especially when the load is <50% of each power supply's capacity. The cold redundancy mode addresses this condition, where certain power supplies in a system can go into "cold standby" mode, thereby consuming the least amount of power and still be redundant.

Each power supply in this system will have a preprogrammed threshold for output current by which that power supply may determine whether to be actively providing power to the system, or be in cold standby state. A CR_BUS signal that connects all power supplies in the system, also indicates whether it is safe for power supplies in cold redundant mode to enter into cold standby state. The CR_BUS signal prevents power supplies from going into cold standby mode whenever there isn't any active power supply.

The following table shows the state of the power supplies programmed for cold standby mode based on the condition of the CR_BUS signal and the load share bus voltage.

Logic Matrix for Cold Standby Power Supplies:

CR_BUS	Load Share	Cold Standby Power Supply State(s)
High	< VCR_ON	Cold Standby
Low	< VCR_ON	Active
High	> VCR_ON	Active
Low	> VCR_ON	Active

Note: VCR_ON is the voltage threshold set inside the power supplies configured for cold standby which tells them to power down into cold standby state when the load share voltage is less than VCR_ON.

When CR_BUS is asserted (or goes low), all power supplies in the system should go active and immediately provide power to the system.

SMBus Commands for Cold Redundancy

Configuring Cold Redundancy with Cold_Redundancy_Config (D0h)

The PMBus™ manufacturer specific command MFR_SPECIFIC_00 is used to configure the operating state of the power supply related to cold redundancy. This command for Cold_Redundancy_Config is D0h. The table below shows the configuration of the power supply based on the value in the Cold_Redundancy_Config register. PEC is used for read/write of this register.

COMMUNICATION BUS DESCRIPTIONS

Cold Redundancy Configuration Table

Cold_Redundancy_Config (D0h)		
Value	State	Description
00h	Standard Redundancy (Default Power on State)	Turns the power supply into standard redundant load sharing mode. The power supply's CR_BUS signal shall be OPEN but still pull the bus low if a fault occurs.
01h	Cold Redundant Active	Defines this power supply to be the one that is always ON in a cold redundancy configuration.
02h	Cold Standby 1	Defines the power supply that is the first to turn on in a cold redundant configuration as the load increases. This power supply usually has the lowest current threshold.
03h	Cold Standby 2	Defines the power supply that is the second to turn on in a cold redundant configuration as the load increases.
04h	Cold Standby 3	Defines the power supply that is the third to turn on in a cold redundant configuration as the load increases.
05h	Always Cold Standby	Defines this power supply to be always in cold redundant configuration no matter what the load condition. Support for this condition will be limited to 1920W maximum output.
06h-FFh	Reserved	

When the CR_BUS transitions from a high to a low state; each PSU programmed to be in cold standby state shall be put into standard redundancy mode (Cold_Redundancy_Config = 00h). For the power supplies to enter cold redundancy mode the system must re-program the power supplies using the Cold_Redundancy_Config command.

Cold Redundant Signal (CR_BUS)

There is an additional signal defined supporting Cold Redundancy. This is connected to a bus shared between the power supplies: CR_BUS. This is a tri-state output signal of the power supply used to communicate a fault or Vout under voltage level has occurred in one of the power supplies. This is used to power on all the power supplies in the system via the CR_BUS. When the signal is pulled high, it allows all power supplies in cold standby mode to go into cold standby state when the load share voltage is below the VCR_ON level. When the signal is left open on all power supplies, it forces all cold standby power supplies into the ON. Below is a table showing the logic state of the CR_BUS signal depending upon the programmed configuration of the power supply in D0h, the operating state of the power supply, and the power supply fault status.

COMMUNICATION BUS DESCRIPTIONS

Cold Redundancy State Table

Cold Redundant Config	Operating State	Power Supply Fault Status	CR_Bus#
Active	On	OK	High
Cold Standby 1,2,3	On	OK	Open
Cold Standby 1,2,3	Cold Standby	OK	Open
Active	Off	Fault	Low
Cold Standby 1,2,3	On	Fault	Low
Cold Standby 1,2,3	Cold Standby	Fault	Low

The CR_Status input is based on both the Cold_Redundancy_Config register as well as the fault state of the power supply. The resulting output is a tri-state output. The output is low when there is a fault in any power supply or when cold redundancy is disabled. The output is high only when a power supply is programmed for the cold redundancy active mode and it is functioning OK. The output is open only when the power supply is programmed for cold redundant standby mode and is functioning OK. This means that there needs to be one good power supply programmed for active cold redundant mode to allow power supply to function in cold standby mode; otherwise, all power supplies will power ON and come out of cold redundant mode.

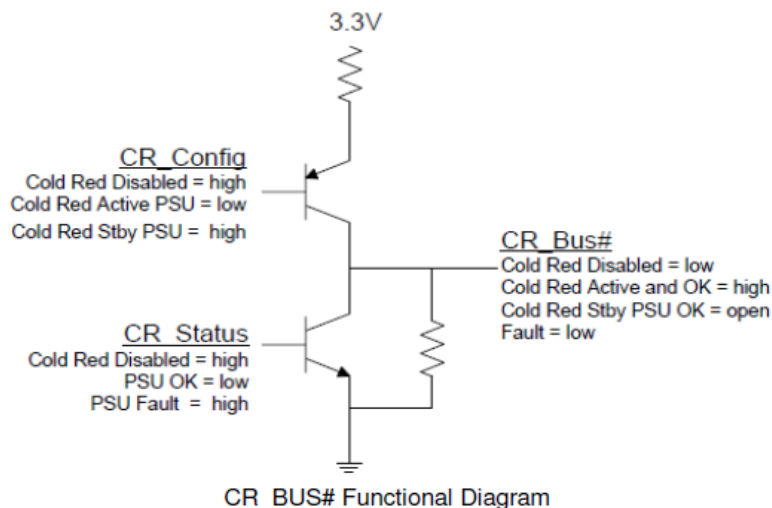

CR_BUS Signal Characteristic

Signal Type	Active: Tri-State Output Cold Standby: Input Signal	
	Min	Max
Logic Level Low (Power Supply ON)	0V	0.4V
Logic Level High (Power Supply OFF)	2.4V	3.46V
Source Current, Cold Amber = High	2mA	-
Sink Current, Cold Amber = Low	400µA	-
Cold Amber Fault Delay	-	10µs
Cold Amber Turn On Delay	-	100µs

COMMUNICATION BUS DESCRIPTIONS

BMC Requirements

The BMC uses the Cold_Redundancy_Config command to configure the power supply's roll in cold redundancy and to enable/disable cold redundancy. It is recommended that the BMC schedules a rolling change for which PSU is the Active, Cold Stby 1, Cold Stby 2, and Cold Stby 3 power supply. This allows for equal loading across power supply over their life.

COMMUNICATION BUS DESCRIPTIONS

Black Box

The power supply can store PMBus and other data into non-volatile memory upon a critical failure that caused the power supply to shut down. The data can be accessed via the PMBus interface by applying power to the 12V_{SB} pins. No AC power needs to be applied to the power supply.

Data is saved to the black box for the following fault events:

- General fault
- Over voltage on output
- Over current on output
- Loss of AC input
- Input voltage fault
- Fan failure
- Over temperature

Black Box Process:

- 1) System writes system tracking data to the power supply RAM at power ON.
- 2) System writes the real time clock data to the PSU RAM once every ~5 minutes.
- 3) Power supply tracks the number of PSON and AC power cycles in FLASH.
- 4) Power supply tracks ON time in FLASH.
- 5) Power supply loads warning and fault event counter data from FLASH into RAM.
- 6) Upon a warning event, the PSU will increment the associated counter in RAM.
- 7) Upon and fault event, the PSU will increment the associated counter in RAM.
- 8) Upon a fault event that causes the PSU to shut down, all event data in the PSU's RAM is saved to event data location N in the power supply's FLASH. This data includes the real time clock, the number of AC & PSON power cycles, PSU ON time, warning event counters and fault event counters.

COMMUNICATION BUS DESCRIPTIONS

Commands:

Name: MFR_BLACKBOX

Format: Read Block with PEC (238 bytes)

Code: DCh

	Item	Number of Bytes	Description
System tracking data	System top assembly number	10	The system will write its Intel part number for the system top assembly to the power supply when it is powered ON. This is 9 ASCII characters.
	System serial number	10	The system will write the system serial number to the power supply when it is powered ON. This includes the serial number and date code.
	Motherboard assembly number	10	The system will write the motherboard Intel part number for the assembly to the power supply when it is powered ON. This is 9 ASCII characters.
	Motherboard serial number	10	The system will write the motherboard's serial number to the power supply when it is powered ON. This includes the serial number and date code.
	Present total PSU ON time	3	Total on time of the power supply with PSON asserted in minutes. LSB = 1 minute.
	Present number of AC power cycles	2	Total number of times the power supply powered OFF then back ON due to loss of AC power. This is only counted when the power supply's PSON signal is asserted. This counter will stay at FFFFh once the max is reached.
	Present number of PSON power cycles	2	Total number of times the power supply is powered OFF then back ON due to the PSON signal de-asserting. This is only counted when AC power is present to the power supply. This counter will stay at FFFFh once the max is reached.
Power supply event data (N)		38	Most recent occurrence of saved black box data.
Time stamp			The power supply will track these time and power cycle counters in RAM. When the a black box event occurs the data is saved into the black box.
	Power supply total power on time	3	Total on time of the power supply in minutes. LSB = 1 minute.
	Real time clock data from system (Reserved for future use)	4	This time stamp does not need to be generated by the power supply. The system rights a real time clock value periodically to the power supply using the MFR_REAL_TIME command. Format is based on IPMI 2.0. Time is an unsigned 32-bit value representing the local time as the number of seconds from 00:00:00, January 1, 1970. This format is sufficient to maintain time stamping with 1 second resolution past the year 2100. This is based on a long standing UNIX-based standard for time keeping, which represents time as the number of seconds from 00:00:00, January 1, 1970 GMT. Similar time formats are used in ANSI C.
	Number of AC power cycles	2	Number of times the power supply powered OFF then back ON due to loss of AC power at the time of the event. This is only counted when the power supply's PSON signal is asserted.
	Number of PSON power cycles	2	Number of times the power supply is powered OFF then back ON due to the PSON signal deasserting at the time of the event. This is only counted when AC power is present to the power supply.

COMMUNICATION BUS DESCRIPTIONS

	Item	Number of Bytes	Description
PMBus			The power supply will save these PMBus values into the black box when a black box event occurs. Fast events may be missed due to the filtering effects of the PMBus sensors.
	STATUS_WORD	2	
	STATUS_IOUT	1	
	STATUS_INPUT	1	
	STATUS_TEMPERTATURE	1	
	STATUS_FAN_1_2	1	
	READ_VIN	2	
	READ_IIN	2	
	READ_IOUT	2	
	READ_TEMPERATURE_1	2	
	READ_TEMPERATURE_2	2	
	READ_FAN_SPEED_1	2	
	READ_PIN	2	
READ_VOUT	2		
Event counters			The power supply will track the total number for each of the following events. These value will be saved to the black box when a black box event occurs. Once a value has reached 15, it will stay at 15 and not reset.
	AC shutdown due to under voltage on input	Lower ½	The power supply will save a count of these critical events to non-volatile memory each time they occur. The counters will increment each time the associated STATUS bit is asserted.
	Thermal shutdown	Upper ½	
	Over current or over power shutdown on output	Lower ½	
	General failure shutdown	Upper ½	
	Fan failure shutdown	Lower ½	
	Shutdown due to over voltage on output	Upper ½	
	Input voltage warning;no shutdown	Lower ½	The power supply will save into RAM a count of these warning events. Events are count only at the initial assertion of the event/bit. If the event persists without clearing the bit the counter will not be incremented. When the power supply shuts down it will save these warning event counters to non-volatile memory. The counters will increment each time the associated STATUS bit is asserted.
	Thermal warning; no shutdown	Upper ½	
	Output current power warning; no shutdown	Lower ½	
Fan slow warning; no shutdown	Upper ½		
Power supply event data (N-1)		38	
Power supply event data (N-2)		38	
Power supply event data (N-3)		38	
Power supply event data (N-4)		38	

COMMUNICATION BUS DESCRIPTIONS

Name: MFR_REAL_TIME_BLACK_BOX
 Format: Write/Read Block with PEC (4 bytes)
 Code: DDh

The system will use this command to periodically write the real time clock data to the power supply.

Format is based on IPMI 2.0. Time is an unsigned 32-bit value representing the local time as the number of seconds from 00:00:00, January 1, 1970. This format is sufficient to maintain time stamping with 1 second resolution past the year 2100.

This is based on a long standing UNIX-based standard for time keeping, which represents time as the number of seconds from 00:00:00, January 1, 1970 GMT. Similar time formats are used in ANSI C.

Name: MFR_SYSTEM_BLACK_BOX
 Format: Write/Read Block with PEC (40 bytes). Low byte first.
 Code: DEh

The system uses this command to write the following data to the PSU.

Item	Bytes	
System top assembly number	1–10	Low bytes
System serial number	11–20	
Motherboard assembly number	21–30	
Motherboard serial number	31–40	High bytes

Name: MFR_BLACKBOX_CONFIG
 Format: Read/Write Byte with PEC
 Code: DFh

Bit	Value	Description
0	0 = disable black box function 1 = enable black box function	Writing a '1' enables the power supply with black box function. Writing a '0' disables the power supply black box function. The state of MFR_BLACKBOX_CONFIG will be saved in non-volatile memory so that it is not lost during power cycling. Intel will receive the power supply with the black box function enabled; bit 0 = '1'.

Name: MFR_CLEAR_BLACKBOX
 Format: Send Byte with PEC
 Code: E0h

The MFR_CLEAR_BLACKBOX command is used to clear all black box records simultaneously. This command is write only. There is no data byte for this command.

COMMUNICATION BUS DESCRIPTIONS

FRU (EEPROM) Data

The FRU (Field Replaceable Unit) data format is compliant with the Intel IPMI v1.0 specification.

The CSU2000AP series uses 1 page of EEPROM for FRU purpose. A page of EEPROM contains up to 256 byte-sized data locations.

- Where: OFFSET -The OFFSET denotes the address in decimal format of a particular data byte within CSU2000AP series EEPROM.
- VALUE -The VALUE details data written to a particular memory location of the EEPROM.
- DEFINITION -The contents DEFINITION refers to the definition of a particular data byte.

CSU2000AP series FRU (EEPROM) Data:

OFFSET		DEFINITION	SPEC VALUE	
(DEC)	(HEX)	(REMARKS)	(DEC)	(HEX)
COMMON HEADER, 8 BYTES				
0	00	FORMAT VERSION NUMBER (Common header) 7:4 - Reserved, write as 0000b 3:0 - Format version number = 1h for this specification	1	01
1	01	INTERNAL USE AREA OFFSET (Not required, do not reserve)	0	00
2	02	CHASSIS INFO AREA OFFSET (Not required, do not reserve)	0	00
3	03	BOARD INFO AREA OFFSET (Not required, do not reserve)	0	00
4	04	PRODUCT INFO AREA OFFSET	4	04
5	05	MULTI RECORD AREA OFFSET	20	14
6	06	PAD (Not required, do not reserve)	0	00
7	07	ZERO CHECK SUM (256 - (Sum of bytes 0 to 6))	NA	NA
8	08	(08h-1Fh is Reserved, default value is 0.)	0	0
9	09		0	0
10	0A		0	0
11	0B		0	0
12	0C		0	0
13	0D		0	0
14	0E		0	0
15	0F		0	0
16	10		0	0
17	11		0	0
18	12		0	0
19	13		0	0
20	14		0	0
21	15		0	0
22	16		0	0
23	17		0	0
24	18		0	0
25	19		0	0
26	1A		0	0
27	1B		0	0
28	1C		0	0
29	1D		0	0
30	1E		0	0
31	1F		0	0
PRODUCT INFORMATION AREA, 128 BYTES				
32	20	FORMAT VERSION NUMBER (Product Info Area) 7:4 - Reserved, write as 0000b 3:0 - Format Version Number = 1h for this specification	1	01

COMMUNICATION BUS DESCRIPTIONS

CSU2000AP series FRU (EEPROM) Data:

OFFSET		DEFINITION	SPEC VALUE	
(DEC)	(HEX)	(REMARKS)	(DEC)	(HEX)
33	21	PRODUCT INFO AREA LENGTH (In multiples of 8 bytes)	16	10
34	22	Language (English)	25	19
35	23	MANUFACTURER NAME TYPE / LENGTH (0CH) 7:6 - (11)b, ASCII code 5:0 - (001100)b, 12 bytes allocation	204	CC
36	24	MANUFACTURER'S NAME 12 bytes sequence "A"= 41h "r"= 72h "t"= 74h "e"= 65h "s"= 73h "y"= 79h "n"= 6Eh	65	41
37	25		114	72
38	26		116	74
39	27		101	65
40	28		115	73
41	29		121	79
42	2A		110	6E
43	2B		32	20
44	2C		32	20
45	2D		32	20
46	2E		32	20
47	2F	32	20	
48	30	PRODUCT NAME Type/Length (24H) 7:6 - (11)b, ASCII code 5:0 - (100100)b, 36 bytes allocation	228	E4
49	31	Product Name , 36 bytes sequence "CRPS: Common Redundant Power Supply " In Decimal = 067d, 082d, 080d, 083d, 058d, 032d, 067d, 111d, 109d, 109d, 111d, 110d, 32d, 82d, 101d, 100d, 117d, 110d, 100d, 97d, 110d, 116d, 32d, 80d, 111d, 119d, 101d, 114d, 32d, 83d, 117d, 112d, 112d, 108d, 121d, 00d In Hex = 43H, 52H, 50H, 53H, 3AH, 20H, 43H, 6FH, 6DH, 6DH, 6FH, 6EH, 20H, 52H, 65H, 64H, 75H, 6EH, 64H, 61H, 6EH, 74H, 20H, 50H, 6FH, 77H, 65H, 72H, 20H, 53H, 75H, 70H, 70H, 6CH, 79H, 00H	67	43
50	32		82	52
51	33		80	50
52	34		83	53
53	35		58	3A
54	36		32	20
55	37		67	43
56	38		111	6F
57	39		109	6D
58	3A		109	6D
59	3B		111	6F
60	3C		110	6E
61	3D		32	20
62	3E		82	52
63	3F		101	65
64	40		100	64
65	41		117	75
66	42		110	6E
67	43		100	64
68	44		97	61
69	45		110	6E
70	46		116	74
71	47		32	20
72	48		80	50
73	49		111	6F
74	4A		119	77
75	4B		101	65
76	4C		114	72
77	4D		32	20
78	4E		83	53
79	4F		117	75
80	50		112	70
81	51		112	70
82	52		108	6C
83	53		121	79
84	54		00	00

COMMUNICATION BUS DESCRIPTIONS

CSU2000AP series FRU (EEPROM) Data:

OFFSET		DEFINITION (REMARKS)	SPEC VALUE	
(DEC)	(HEX)		(DEC)	(HEX)
85	55	PRODUCT PART/MODEL NUMBER Type/Length (10H) 7:6 - (11)b, ASCII code 5:0 - (010000)b, 16-byte allocation	16	10
86	56	Part / Model Number "CSU2000AP-3-100 " In Decimal = 067d, 083d, 085d, 050d, 048d, 048d, 048d, 065d, 080d, 045d, 051d, 045d, 049d, 048d, 048d, 032d In Hex = 43H, 53H, 55H, 32H, 30H, 30H, 30H, 41H, 50H, 2DH, 33H, 2DH, 31H, 30H, 30H, 20H	67	43
87	57		83	53
88	58		85	55
89	59		50	32
90	5A		48	30
91	5B		48	30
92	5C		48	30
93	5D		65	41
94	5E		80	50
95	5F		45	2D
96	60		51	33
97	61		45	2D
98	62		49	31
99	63		48	30
100	64		48	30
101	65	32	20	
102	66	PRODUCT VERSION NUMBER Type/Length (10h) 7:6 - (11)b, ASCII code 5:0 - (010000)b, 16-byte allocation	16	10
103	67	Version , 16 bytes sequence "XXXXXXXXXXXXXXXXXX"	XX	XX
104	68		XX	XX
105	69		XX	XX
106	6A		XX	XX
107	6B		XX	XX
108	6C		XX	XX
109	6D		XX	XX
110	6E		XX	XX
111	6F		XX	XX
112	70		XX	XX
113	71		XX	XX
114	72		XX	XX
115	73		XX	XX
116	74		XX	XX
117	75		XX	XX
118	76		XX	XX
119	77	PRODUCT SERIAL NUMBER Type/Length 7:6 - (11)b, ASCII code 5:0 - (001110)b, 14-byte allocation	14	0E
120	78	Serial number , 14 bytes sequence "XXXXXXXXXXXXXXXXXX"	XX	XX
121	79		XX	XX
122	7A		XX	XX
123	7B		XX	XX
124	7C		XX	XX
125	7D		XX	XX
126	7E		XX	XX
127	7F		XX	XX
128	80		XX	XX
129	81		XX	XX
130	82		XX	XX
131	83		XX	XX
132	84		XX	XX
133	85		XX	XX

COMMUNICATION BUS DESCRIPTIONS

CSU2000AP series FRU (EEPROM) Data:

OFFSET		DEFINITION (REMARKS)	SPEC VALUE	
(DEC)	(HEX)		(DEC)	(HEX)
134	86	PAD (reserved) Default value is 0.	0	00
135	87		0	00
136	88	ZERO CHECK SUM (256-(sum of bytes 32 to 135)) Per Unit Zero Check Sum: should follow check sum calculation as per IPMI v1.3 specs	NA	NA
137	89	(88h-9Eh is Reserved, default value is 0.)	0	0
138	8A		0	0
139	8B		0	0
140	8C		0	0
141	8D		0	0
142	8E		0	0
143	8F		0	0
144	90		0	0
145	91		0	0
146	92		0	0
147	93		0	0
148	94		0	0
149	95		0	0
150	96		0	0
151	97		0	0
152	98		0	0
153	99		0	0
154	9A		0	0
155	9B		0	0
156	9C	0	0	
157	9D	0	0	
158	9E	0	0	
159	9F	0	0	
MULTI RECORD AREA, 96 BYTES				
Power Supply Record Header				
160	A0	Record type = 00 for power supply info	0	00
161	A1	End of list / Record format version number for 12V output record	2	02
162	A2	Record length of 12V output record	24	18
163	A3	Record checksum	NA	NA
164	A4	Header checksum	NA	NA
POWER SUPPLY RECORD				
Combined Wattage, 2000W = 07D0H				
2 bytes sequence				
165	A5	Byte 1 (LSB) = 08h = D0d	208	D0
166	A6	Byte 2 (MSB) = 07h = 07d	07	07
Peak VA, 2187W = 088B				
2 bytes sequence				
167	A7	Byte 1 (LSB) = 8Bh	139	8B
168	A8	Byte 2 (MSB) = 08h	08	08
Inrush Current, 35A				
In Decimal = 35d In Hex = 23H				
169	A9		35	23
Inrush Interval, 255mS				
In Decimal = 255d In Hex = FFH				
170	AA		255	FF
Low End Input Voltage Range 1(10mV), (90V/10mV) 9000=2328H				
2 bytes sequence				
171	AB	Byte 1 (LSB) = 28h	40	28
172	AC	Byte 2 (MSB) = 23h	35	23

COMMUNICATION BUS DESCRIPTIONS

CSU2000AP series FRU (EEPROM) Data:

OFFSET		DEFINITION (REMARKS)	SPEC VALUE	
(DEC)	(HEX)		(DEC)	(HEX)
173 174	AD AE	High End Input Voltage Range 1(10mV), (127V/10mV) 12700=319CH 2 bytes sequence Byte 1 (LSB) = 9Ch Byte 2 (MSB) = 31h	156 49	9C 31
175 176	AF B0	Low End Input Voltage Range 2(10mV), (180V/10mV) 18000=4650H 2 bytes sequence Byte 1 (LSB) = 50h Byte 2 (MSB) = 46h	80 70	50 46
177 178	B1 B2	High End Input Voltage Range 2(10mV), (240V/10mV) 24000=5DC0H 2 bytes sequence Byte 1 (LSB) = C0h Byte 2 (MSB) = 5Dh	192 93	C0 5D
179	B3	Low End Input Frequency Range	00	00
180	B4	Low End Input Frequency Range	00	00
181	B5	AC Dropout Tolerance in ms, 1mS = 01H	01	01
182	B6	Binary Flags: For each of the following binary flags No = 0, Yes = 1. Bits 7-5: RESERVED, Write as 000b Bit4: Tachometer Pulses Per Rotation / Predictive Fail Polarity BIT = 0 Bit3: Hot Swap / Redundancy Support BIT = 1 Bit2: Auto switch Support BIT = 0 Bit1: Power Factor Correction Support BIT = 1 Bit0: Predictive Fail Support BIT = 1	11	0B
183 184	B7 B8	Peak Wattage Capacity and Holdup Time, (Set for 2732Watts/15mS) In Decimal = 26 In Hex = 1AH (LSB First) In Decimal = 249 In Hex = F9H	26 249	1A F9
185 186 187	B9 BA BB	Combined Wattage, 2000W = 07D0H 2 bytes sequence Byte 1 (LSB) = 08h = D0d Byte 2 (MSB) = 07h = 07d	204 208 07	CC D0 07
188	BC	Predictive Fail Tachometer Lower Threshold, Not Applicable. Predictive failure is not supported.	00	00
12V OUTPUT RECORD HEADER				
189 190 191 192 193	BD BE BF C0 C1	Record Type = 01 for power supply info End of List / Record Format Version Number for 12V Output Record Record Length of 12V Output Record Record checksum (256-(sum of bytes 194 to 206)) Header checksum (256-(sum of bytes 189 to 192))	01 02 13 NA NA	01 02 0D NA NA
12V OUTPUT RECORD				
194	C2	Output Information, 000 = 00H Bit 7: Standby information = 0b Bits 6-5: Reserved, write as 000b Bits 4: Current units, 0b = 10mA Bits 3-0: Output number 0 = 000b	00	00
195 196	C3 C4	Nominal Voltage (10mV), (12.2V / 10mV) 1220 = 04C4H 2 bytes sequence In Decimal: 196d, 004d In Hex: C4H, 04H	196 04	C4 04

COMMUNICATION BUS DESCRIPTIONS

CSU2000AP series FRU (EEPROM) Data:

OFFSET		DEFINITION (REMARKS)	SPEC VALUE	
(DEC)	(HEX)		(DEC)	(HEX)
197 198	C5 C6	Maximum Negative Voltage Deviation (11.8V / 10mV) , 1180 = 049CH 2 bytes sequence In Decimal: 156d, 004d In Hex: 9CH, 04H	156 04	9C 04
199 200	C7 C8	Maximum Positive Voltage Deviation (12.6V / 10mV) , 1260 = 04ECH 2 bytes sequence In Decimal: 000d, 005d In Hex: 00H, 05H	00 05	00 05
201 202	C9 CA	Ripple and Noise pk-pk (mV) , 120 = 78H 2 bytes sequence In Decimal: 120d, 000d In Hex: 78H, 00H	120 0	78 00
203 204	CB CC	Minimum Current Draw (mA) , 1000 = 03E8H 2 bytes sequence In Decimal: 232d, 003d In Hex: E8H, 03H	232 03	E8 03
205 206	CD CE	Maximum Current Draw (mA) , 19670 = 4CD6H 2 bytes sequence In Decimal: 214d, 114d In Hex: D6H, 4CH	214 114	D6 4C
12VSB OUTPUT RECORD HEADER				
207	CF	Record type = 01 for DC Output Record	01	01
208	D0	End of List / Record Format Version Number for 12V _{SB} Output Record	130	82
209	D1	Record Length of 12V DC Output Record	13	0D
210	D2	Record CHECKSUM of 12V _{SB} Output Record	NA	NA
211	D3	Header CHECKSUM of 12V _{SB} Output Record Header	NA	NA
12VSB OUTPUT RECORD				
212	D4	Output Information , 129 = 81H Bit 7: Standby Information = 1b Bits 6-4: Reserved, write as 000b Bits 3-0: Output number 1 = 0001b	129	81
213 214	D5 D6	Nominal Voltage (10mV), (12V / 10mV) 1200 = 04B0H 2 bytes sequence In Decimal: 176d, 004d In Hex: B0H, 04H	176 4	B0 04
215 216	D7 D8	Maximum Negative Voltage Deviation (10mV) , 1140 = 0474H 2 bytes sequence In Decimal: 116d, 004d In Hex: 74H, 04H	116 04	74 04
217 218	D9 DA	Maximum Positive Voltage Deviation (10mV) , 1260 = 04ECH 2 bytes sequence In Decimal: 236d, 004d In Hex: ECH, 04H	236 4	EC 04
219 220	DB DC	Ripple and Noise pk-pk (mV) , 120 = 78H 2 bytes sequence In Decimal: 120d, 000d In Hex: 78H, 00H	120 0	78 00
221 222	DD DE	Minimum Current Draw (10mA) , 0000 = 0000H 2 bytes sequence In Decimal: 000d, 000d In Hex: 00H, 00H	0 0	00 00

COMMUNICATION BUS DESCRIPTIONS

CSU2000AP series FRU (EEPROM) Data:

OFFSET		DEFINITION (REMARKS)	SPEC VALUE	
(DEC)	(HEX)		(DEC)	(HEX)
		Maximum Current Draw (10mA), 3500 = 0DACH		
223	DF	2 Bytes Sequence	172	AC
224	E0	In Decimal: 172d, 13d In Hex: ACH, 0DH	13	0D
225	E1	(E1h-FFh is reserved. Default value is 0.)	0	00
226	E2		0	00
227	E3		0	00
228	E4		0	00
229	E5		0	00
230	E6		0	00
231	E7		0	00
232	E8		0	00
233	E9		0	00
234	EA		0	00
235	EB		0	00
236	EC		0	00
237	ED		0	00
238	EE		0	00
239	EF		0	00
240	F0		0	00
241	F1		0	00
242	F2		0	00
243	F3		0	00
244	F4		0	00
265	F5		0	00
246	F6		0	00
247	F7		0	00
248	F8		0	00
249	F9		0	00
250	FA		0	00
251	FB	0	00	
252	FC	0	00	
253	FD	0	00	
254	FE	0	00	
255	FF	0	00	

PMBUS™ SPECIFICATIONS

The CSU2000AP series is compliant with the industry standard PMBus™ protocol for monitoring and control of the power supply via the I²C interface port.

CSU2000AP Series PMBus™ General Instructions

Equipment Setup

The following is typical I²C communication setup:

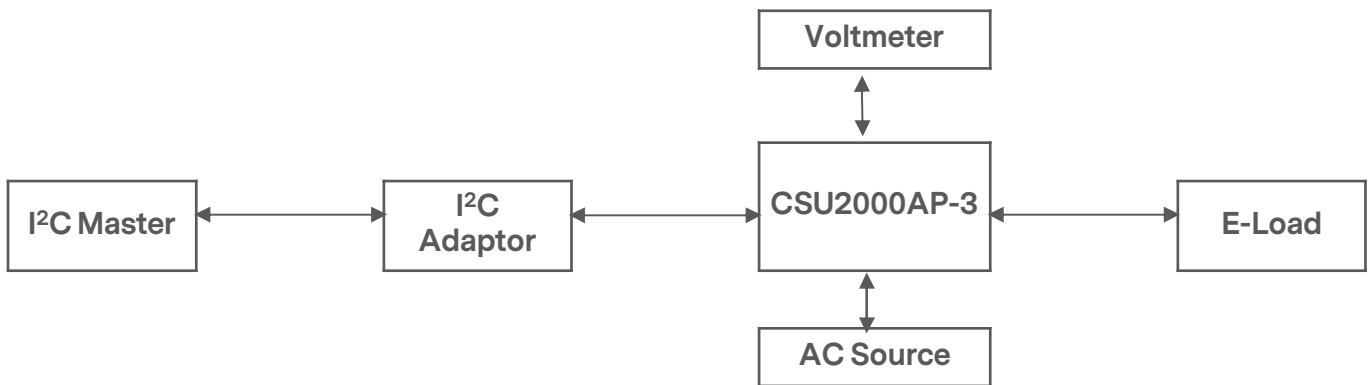

I²C Accuracy

Output Load	Input Voltage	Input Current	Input Power	Output Voltage	Output Current	Output Power	Temperature	Fan Speed
40W to 200W	±3%	±0.1A	±5W	±3%	±1A	±10W	±3°C	250RPM
200W to 300W	±3%	±2%	±2%	±3%	±4%	±4%	±3°C	250RPM
300W to full load	±2%	±2%	±2%	±2%	±2%	±2%	±3°C	250RPM

PMBUS™ SPECIFICATIONS

The CSU2000AP Series Supported PMBus™ Command List:

Command Code	Command Name	Default Value	Access Type	Data Bytes	Data Format	Description
00h	PAGE	00	R	1	Hex	Valid input: 00h
01h	OPERATION	80	R/W	1	Bitmapped	Default : 80h Valid input: 80h, 40h
03h	CLEAR_FAULTS	00	S		N/A	Page Support If the page is set to FFh, both BMC and ME STATUS bits are cleared.
05h	PAGE_PLUS_WRITE		BW		N/A	
06h	PAGE_PLUS_READ		BR		N/A	
19h	CAPABILITY	B0	R	1	Bitmapped	Provides a way for the hosts system to determine some key capabilities of a PMBus™ device.
	b7 - Packet Error Checking	1				0 - PEC not supported 1 - PEC supported
	b6:5 - Maximum Bus Speed	01				00 - Maximum supported bus speed, 100KHz 01 - Maximum supported bus speed, 400KHz 10 - Maximum supported bus speed, 1MHz 11 - Reserved
	b4 - SMBALERT#	1				0 - SMBus Alert Pin not supported 1 - SMBus Alert Pin supported
	b3 - Numeric Format	0				0 - Linear11, Ulinear16, Slinear16, or Direct 1 - IEEE half precision floating point format
	b2 - AVSBus	0				0 - AVSBus not supported 1 - AVSBus supported
	b1:0	00				Reserved
1Ah	QUERY	-	BR/BW		N/A	Supported in ISP mode
1Bh	SMBALERT_MASK	-	BR/BW		N/A	Default masks per Intel spec: Page 00: STATUS_VOUT = FFh STATUS_IOUT = FFh STATUS_INPUT = FFh STATUS_TEMP = FFh STATUS_CML = FFh Page 01: STATUS_VOUT = FFh STATUS_IOUT = DFh STATUS_INPUT = EFh STATUS_TEMP = BFh STATUS_CML = FFh Non-paged: STATUS_FANS_1_2 = FFh
20h	VOUT_MODE	17	R	1	Bitmapped	Specifies the mode and parameters of output voltage related data formats

PMBUS™ SPECIFICATIONS

The CSU2000AP Series Supported PMBus™ Command List:

Command Code	Command Name	Default Value	Access Type	Data Bytes	Data Format	Description
30h	COEFFICIENTS		BW/BR	5	Hex	Use to retrieve the m, b and R coefficients, needed for DIRECT data format.
	byte 5	00				R byte
	byte 4:3	0000				b low byte, b high byte
	byte 2:1	0000				m low byte, m high byte
3Ah	FAN_CONFIG_1_2	D0	R/W	1	Bitmapped	Default RPM Mode.
3Bh	FAN_COMMAND_1	0000	R/W	2	Linear	Adjusts the operation of the Fans in RPM. The device may override the command, if it requires higher value to maintain proper device temperature.
46h	IOUT_OC_FAULT_LIMIT	F314	R/W	2	Linear	Sets the over current threshold in Amps. (197.00A)
4Ah	IOUT_OC_WARNING_LIMIT	F308	R/W	2	Linear	Sets the over current warning threshold in Amps. (194.00A)
51h	OT_WARN_LIMIT (Hot Spot)	EBB0	R/W	2	Hex	Secondary ambient temperature warning threshold, in degree C. Operating limit (118degC)
5Dh	IIN_OC_WARN_LIMIT	D280	R/W	2	Linear	Sets the over current threshold in Amps. (10A)
68h	POUT_OP_FAULT_LIMIT	12FA	R/W	2	Linear	Sets the output over power threshold in Watt. (3048W)
6Ah	POUT_OP_WARN_LIMIT	129F	R/W	2	Linear	Sets the output over power threshold in Watt. (2684W)
6Bh	PIN_OP_WARN_LIMIT	1232	R/W	2	Linear	Sets the over power threshold in Watt. (2248W)
78h	STATUS_BYTE	-	R	1	Bitmapped	Returns the summary of critical faults.
	b7 - BUSY					Not supported.
	b6 - OFF					Unit is OFF.
	b5 - VOUT_OV_Fault					Not supported.
	b4 - IOUT_OC_Fault					Output over-current fault has occurred.
	b3 - VIN_UV_Fault					An input under-voltage fault has occurred.
	b2 - TEMPERATURE					A temperature fault or warning has occurred.
	b1 - CML					A communication, memory or logic fault has occurred.

PMBUS™ SPECIFICATIONS

The CSU2000AP Series Supported PMBus™ Command List:

Command Code	Command Name	Default Value	Access Type	Data Bytes	Data Format	Description
79h	STATUS_WORD	-	R	2	Bitmapped	Summary of units fault and warning status.
	b15 - VOUT					An output voltage fault or warning has occurred.
	b14 - IOUT					An output current or power fault or warning has occurred.
	b13 - INPUT					An input voltage, current or power fault or warning as occurred.
	b11 - POWER_GOOD#					The POWER_GOOD signal is de-asserted.
	b10 - FANS					Not supported.
	b6 - OFF					Unit is OFF.
	b5 - VOUT_OV_FAULT					Output over-voltage fault has occurred
	b4 - IOUT_OC_FAULT					Output over-current fault has occurred.
	b3 - VIN_UV_FAULT					An input under-voltage fault has occurred.
	b2 - TEMPERATURE					A temperature fault or warning has occurred.
	b1 - CML					A communication, memory or logic fault has occurred.
	b0 - NONE OF THE ABOVE					
7Ah	STATUS_VOUT	-	R	1	Bitmapped	
	b7 - VOUT Over-Voltage Fault	-				VOUT over-voltage fault
	b4 - VOUT Under-Voltage Fault	-				VOUT under-voltage fault
7Bh	STATUS_IOUT		R	1	Bitmapped	
	b7 - IOUT Overcurrent Fault					IOUT overcurrent fault
	b5 - IOUT Overcurrent Warning					IOUT overcurrent warning
	b1 - POUT_OP_FAULT					POUT overpower fault
	b0 - POUT_OP_WARNING					POUT overpower warning
7Ch	STATUS_INPUT		R	1	Bitmapped	Input related faults and warnings
	b7 - VIN_OV_FAULT					Not supported
	b6 - VIN_OV_WARNING					VIN over-voltage warning
	b5 - VIN_UV_WARNING					VIN under-voltage warning
	b4 - VIN_UV_FAULT					VIN under-voltage fault
	b3 - Unit Off For Low Input Voltage					Unit is Off for insufficient input voltage.
	b2 - IIN_OC_FAULT					IIN overcurrent fault
	b1 - IIN_OC_WARNING					IIN overcurrent warning
b0 - PIN_OP_WARNING					PIN overpower warning	
7Dh	STATUS_TEMPERATURE		R	1	Bitmapped	Temperature related faults and warnings
	b7 - Over Temperature Fault					Over temperature fault
	b6 - Over Temperature Warning					Over temperature warning

PMBUS™ SPECIFICATIONS

The CSU2000AP Series Supported PMBus™ Command List:

Command Code	Command Name	Default Value	Access Type	Data Bytes	Data Format	Description
7Eh	STATUS_CML		R	1	Bitmapped	Communications, logic and memory
	b7 - Invalid/Unsupported command					Invalid or unsupported command received
	b6 - Invalid/Unsupported Data					Invalid data
	b5 - Packet Error Check Failed					Packet error check failed
80h	STATUS_MFR_SPECIFIC		R	1	Hex	00h - No input 01h - AC input 02h - DC input
81h	STATUS_FANS_1_2		R	1	Bitmapped	
	b7 - Fan1 Fault					Fan1 Fault
	b5 - Fan1 Warning					Fan1 Warning
	b3 - Fan1 Speed Overridden					Fan1 Speed Overridden
86h	Ein		BR	6	Direct	Returns the accumulated input power over time.
87h	Eout		BR	6	Direct	Returns the accumulated output power over time.
88h	READ_VIN		R	2	Linear	Returns input voltage in Volts ac.
89h	READ_IIN		R	2	Linear	Returns input current in Amperes.
8Bh	READ_VOUT		R	2	Linear	Returns the actual, measured voltage in Volts.
8Ch	READ_IOUT		R	2	Linear	Returns the output current in amperes.
8Dh	READ_TEMPERATURE_1		R	2	Linear	Returns the inlet temperature in degree Celsius.
8Eh	READ_TEMPERATURE_2		R	2	Linear	Returns the primary hot pot temperature in degree Celsius.
8Fh	READ_TEMPERATURE_3		R	2	Linear	Returns the secondary hot pot temperature in degree Celsius.
90h	READ_FAN_SPEED_1		R	2	Linear	Speed of fan 1
96h	READ_POUT		R	2	Linear	Returns the output power, in Watts.
97h	READ_PIN		R	2	Linear	Returns the input power, in Watts.
98h	PMBUS_REVISION	22	R	1	Bitmapped	Reads the PMBus revision number.
	b7:5	0010				Part 1 Revision 0000 - Revision 1.0 0001 - Revision 1.1 0010 - Revision 1.2
	b4:0	0010				Part 2 Revision 0000 - Revision 1.0 0001 - Revision 1.1 0010 - Revision 1.2
99h	MFR_ID	Artesyn (0x41 72 74 65 73 79 6E 20 20 20 20 20)	BR	12	ASCII	Supported in ISP mode linked to FRU Default: "Artesyn"

PMBUS™ SPECIFICATIONS

The CSU2000AP Series Supported PMBus™ Command List:

Command Code	Command Name	Default Value	Access Type	Data Bytes	Data Format	Description
9Ah	MFR_MODEL	Eg: CSU2000AP-3-100 (0x43 53 55 32 30 30 30 41 50 2D 33 2D 31 30 30 20)	BR	16	ASCII	Supported in ISP mode linked to FRU Model number matching label.
9Bh	MFR_REVISION	NA	BR	6	ASCII	Linked to FRU Format "Release - 00xx"
9Ch	MFR_LOCATION		BR	7	ASCII	
9Dh	MFR_DATE		BR	4	ASCII	
9Eh	MFR_SERIAL		BR	15	ASCII	Linked to FRU
A0h	MFR_VIN_MIN	00B4	R	2	Linear	Minimum high line input voltage (180Vac)
A1h	MFR_VIN_MAX	0108	R	2	Linear	Maximum input voltage (264Vac)
A4h	MFR_VOUT_MIN	1733	R	2	Linear	Minimum output voltage Regulation window (11.6V)
A5h	MFR_VOUT_MAX	199A	R	2	Linear	Maximum output voltage. Regulation window (12.8V)
A6h	MFR_IOUT_MAX	F290	R	2	Linear	Maximum output current (163.9A)
A7h	MFR_POUT_MAX	11F4	R	2	Linear	Maximum output power (2000W)
C0h	MFR_MAX_TEMP_1 (Ambient)	0037	R	2	Linear	Maximum continuous ambient operating temperature (Normal air flow: 55degC Reverse air flow: 40degC)
C1h	MFR_MAX_TEMP_2 (hot Spot)	0076	R	2	Linear	Maximum hot spot temperature (118degC)
D0h	Cold_Redundancy_Config	00	R/W	1	Hex	00 - Normal 01 - Active 02 - Cold standby 1 03 - Cold standby 2 04 - Cold standby 3 05 - Always cold standby
DDh	MFR_REAL_TIME_BLACK_BOX		BR/BW	4		
DEh	MFR_SYSTEM_BLACK_BOX		BR/BW	40		
DFh	MFR_BLACKBOX_CONFIG		R/W			
E0h	MFR_CLEAR_BLACKBOX		W			

Note 1 - MFR_MAX_TEMP_2 (hot spot) is the maximum hot spot temperature where the power supply can continue to operate without shutting down the main output. This corresponds to the over temperature warning value.

PMBUS™ SPECIFICATIONS

The CSU2000AP Series Firmware Update Command List:
The power supply uses the following commands during the bootload process.

Command Code	Command Name	Default Value	Access Type	Data Bytes	Description
D4h	MFR_HW_COMPATIBILITY	-	R	-	This is a COMPATIBILITY value used to tell if there are any changes in the FW that create an incompatibility with the FW. This value only changes when the PSU HW is changed creating an incompatibility with older versions of FW.
D5h	MFR_FWUPLOAD_CAPABILITY	-	R	-	The system can read the power supply's FW upload mode capability using this command. For any given power supply, more than one FW upload mode may be supported. The supported FW upload mode(s) must support updating all available FW in the power supply. This power supply supports FW uploading in standby mode only. Bit 0: "1" FW uploading in standby mode only All other bits configurations are not supported.
D6h	MFR_FWUPLOAD_MODE	-	R/W	-	Writing a "1" puts the power supply into firmware upload mode and gets it ready to receive the first image block via the MFR_FW_UPLOAD command. The system can use this command at any time to restart sending the FW image. Writing a "0" puts the power supply back into normal operating mode. Writing a "1" restart. This command will put the PSU into standby mode if the PSU supports FW update in standby mode only. If the power supply image passed to the PSU is corrupt the power supply will stay in firmware upload mode even if the system requested the PSU to exit the FW upload mode. Value: 0 = Exit firmware upload mode 1 = Firmware upload mode
D7h	MFR_FWUPLOAD	-	BW	-	Command used to send each block of the FW image.
D8h	MFR_FWUPLOAD_STATUS	-	R	2	At any time during or after the firmware image upload the system can read this command to determine status of the firmware upload process. All bits get reset to "0" when the power supply enters FW upload mode. Bit 0: "1" full image received Bit 1: "1" full image not received. This remains asserted until the full image is received Bit 2: "1" bad or corrupt image received Bit 3: For future use Bit 4: "1" FW image is not supported and not received Bit 5-15: Reserved
D9h	MFR_FW_REVISION	NA	BR	3	Supported in ISP mode Label vAA.BB.CC returns 0xCCBBAA.

Noted: While the PSU FW image is being updated the PSU will blink the green LED at a 2Hz rate.

PMBUS™ SPECIFICATIONS

Firmware Update Process

BMC uses these commands to determine if FW needs updating:
 MFR_FW_REVISION
 MFR_MODEL
 MFR_FW_UPLOAD_MODE
 MFR_HW_COMPATIBILITY
 MFR_FW_UPLOAD_CAPABILITY

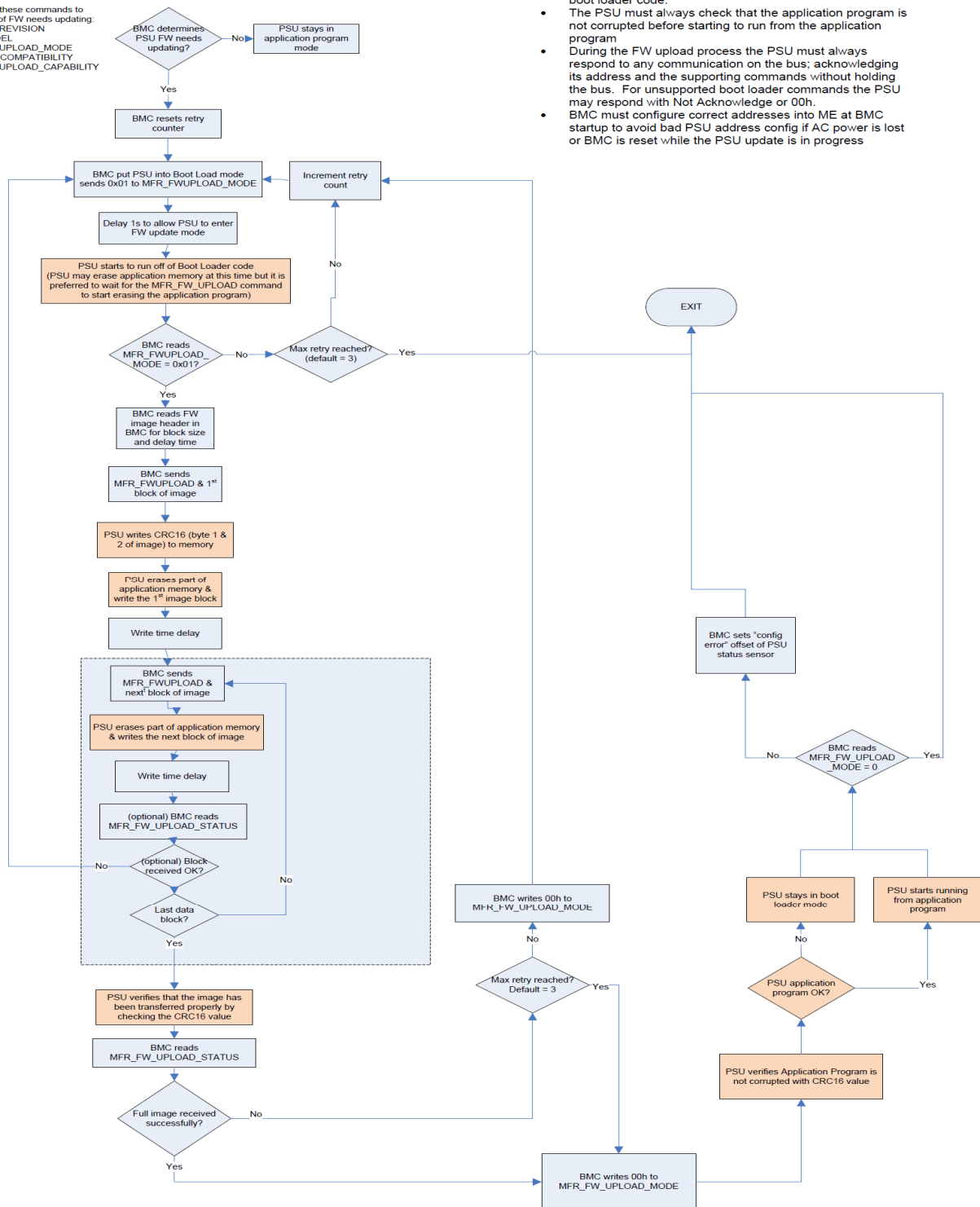

IMPORTANT!

- PSU may be in standby mode or ON mode during FW update process
- If the FW update process is interrupted at any point during the process; the PSU must always be able to return to the boot loader code.
- The PSU must always check that the application program is not corrupted before starting to run from the application program
- During the FW upload process the PSU must always respond to any communication on the bus; acknowledging its address and the supporting commands without holding the bus. For unsupported boot loader commands the PSU may respond with Not Acknowledge or 00h.
- BMC must configure correct addresses into ME at BMC startup to avoid bad PSU address config if AC power is lost or BMC is reset while the PSU update is in progress

PMBUS™ SPECIFICATIONS

PSU Flow During Powering ON

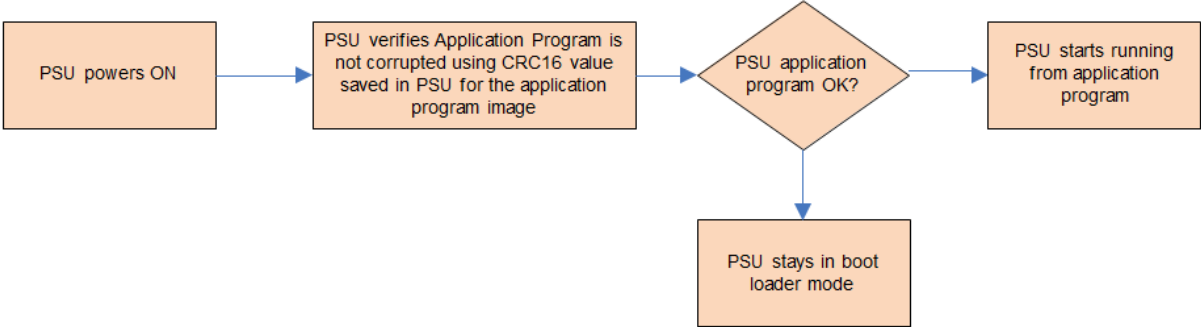

APPLICATION NOTES

Current Sharing

The CSU2000AP series main output V_O is equipped with current sharing capability. This will allow up to 5+1 power supplies to be connected in parallel for higher power application. Current share accuracy is typically 6% when the load is larger than 25%. Below 7% total loading, there is no guarantee of output current sharing.

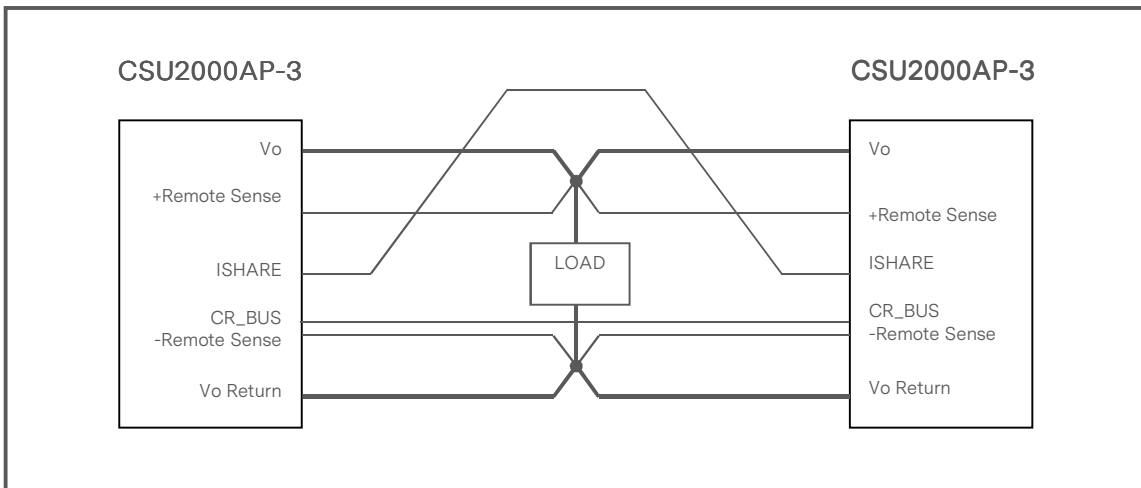

APPLICATION NOTES

Output Ripple and Noise Measurement

The setup outlined in the diagram below has been used for output voltage ripple and noise measurements on the CSU2000AP series. When measuring output ripple and noise, a scope jack in parallel with a 0.1uF ceramic chip capacitor, and a 10uF tantalum capacitor will be used. Oscilloscope can be set to 20MHz bandwidth for this measurement.

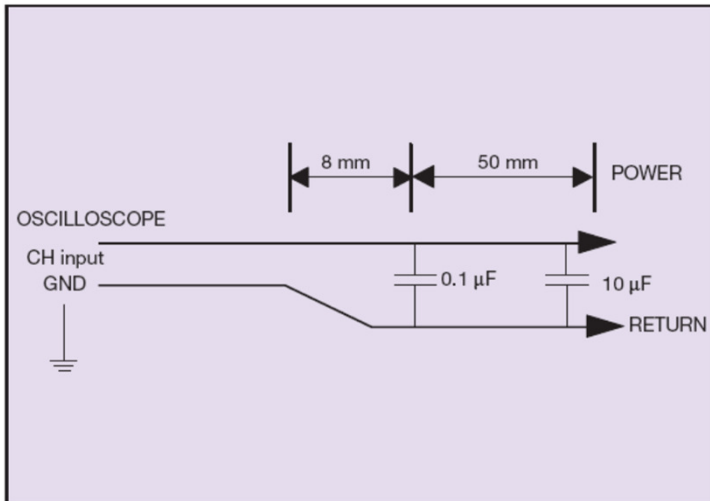

RECORD OF REVISION AND CHANGES

Issue	Date	Description	Originators
1.0	11.01.2019	First issue	K. Zou
1.1	08.26.2020	<ol style="list-style-type: none"> 1. Add reverse airflow models 2. Add standby current share information 3. Add pantone of the handle 4. Add I²C Reading Accuracy 5. Update Mechanical Drawing picture 6. Add Thermal Derating Curve 7. Update operating temperature note 	K. Zou
1.2	12.30.2020	Update I ² C reading data	K. Zou
1.3	03.02.2021	Update cover and back cover	C. Liu
1.4	04.30.2021	<ol style="list-style-type: none"> 1. Update the C0h, C1h description 2. Add the VIN_GOOD characteristics in the performance curve 	A. Zhang
1.5	06.08.2021	Update the cap load spec	A. Zhang
1.6	06.28.2021	<ol style="list-style-type: none"> 1. Update dV/dt requirement in Timing 2. Update the T12 requirement 	K. Zou
1.7	09.22.2021	<ol style="list-style-type: none"> 1. Update the PMBus™ command 8D, 8E, 8F, 9Ch and 9Dh 2. Add note 7 on page 3 	A. Zhang
1.8	02.15.2022	Update 99h,9Ah typo	K. Wang
1.9	03.14.2023	Update SDA, SCL pull-up resistor value, and update access type of commands 46h, 4Ah, 51h, 5Dh, 68h, 6Ah, 6Bh	A. Zhang
2.0	03.21.2024	Update mating connector	Leo.Li



For international contact information,
visit [advancedenergy.com](https://www.advancedenergy.com).

powersales@aei.com (Sales Support)
productsupport.ep@aei.com (Technical Support)
+1 888 412 7832

ABOUT ADVANCED ENERGY

Advanced Energy (AE) has devoted more than three decades to perfecting power for its global customers. AE designs and manufactures highly engineered, precision power conversion, measurement and control solutions for mission-critical applications and processes.

Our products enable customer innovation in complex applications for a wide range of industries including semiconductor equipment, industrial, manufacturing, telecommunications, data center computing, and medical. With deep applications know-how and responsive service and support across the globe, we build collaborative partnerships to meet rapid technological developments, propel growth for our customers, and innovate the future of power.

PRECISION | POWER | PERFORMANCE | TRUST

Specifications are subject to change without notice. Not responsible for errors or omissions. ©2023 Advanced Energy Industries, Inc. All rights reserved. Advanced Energy®, and AE® are U.S. trademarks of Advanced Energy Industries, Inc.

CSU2000AP Rev.03.21.24_#2.0