

SL POWER MINT1175 Series

175 Watts Single Output
Medical Grade

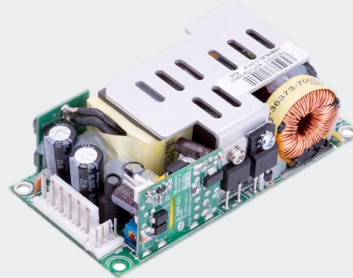

Advanced Energy's SL Power MINT1175 series is a high power density for a power supply in a 2"x4" size. Approved to EN/IEC/UL 60601-1, 3rd edition, with isolation levels which satisfy the 2MOPP requirements. The MINT1175 series is ideal for portable medical devices, and many other applications where medical certifications, power density and cost are critical. The MINT1175 series operates at universal input range of 90 to 264Vac and wide temperature range -10 °C to 70 °C, delivering full rated output power up to +50 °C. In addition, these models feature Power Fail and DC OK signals.

AT A GLANCE

Total Power

175 Watts

Input Voltage

90 to 264 VAC

of Outputs

Single

SPECIAL FEATURES

- 2" x 4" x 1.3" Package
- 175 W with air, 120 W Convection Cooled
- Universal Input 90 to 264 VAC
- Efficiency 90% Typical at Full Load
- Average Efficiency meets Level V Requirements
- Suitable for 1U Applications
- 2 x MOPP Input to Output Isolation
- Class I and Class II Versions
- 12V Fan Output
- Power Fail Signal
- DC OK Signal
- 3 Year Warranty
- RoHS Compliant

SAFETY

- CSA/IEC/EN/UL60601-1, 3rd Edition
- CE Mark



ELECTRICAL SPECIFICATIONS

Input	
Input range	90 to 264 VAC, 47 to 63 Hz, 1 ϕ ; 120 to 370 VDC
Input current	2 A @ 115 VAC, 1 A @ 230 VAC
Inrush current	50 A max, cold start @ 264 VAC input
Input fuses	4 A, 250 VAC fuses provided in both line & neutral
Turn on input voltage	82.7 VAC nom
Turn off input voltage	67 VAC nom
Power Factor	0.9 min
Earth Leakage current	<200 μ A @ 264 VAC, 60 Hz, NC <400 μ A @ 264 VAC, 60 Hz, SFC
Efficiency	90% typical @ 115 VAC
Isolation voltage	Input/Ground: 1800 VAC (1 x MOPP) Input/Output: 4000 VAC (2 x MOPP) Output/Ground: 1500 VAC
Output	
Output power	175 W continuous with 200 LFM airflow, 120 W convection cooled
Ripple and noise	See "Ordering Information"
Total regulation	See "Ordering Information"
Output voltage	See "Ordering Information"
Switching Frequency	PFC: Fixed, 65kHz. Main Converter: Variable 35-200kHz, 65-70kHz at full load
Adjustment range	+/-5% from nominal
Turn on time	< 2 s @ 115 VAC (inversely proportional to input voltage and thermistor temperature)
Hold-up time	16 mS typical @ 120 W load
Minimum load	Not required
Dynamic load regulation	< 3% of nominal output voltage @ 50% load change, di/dt = 0.2 A/ μ S
Reliability	
MTBF	331,000 hrs @ 110 VAC Input, 25°C Ambient
Protection	
Input fuses	4 A, 250 VAC fuses provided in both line & neutral
Input transient protection	2kV (CM) and 1kV (DM) surge
Short circuit protection	Provided - no damage will occur if the output is shorted.
Overload protection	Hiccup mode
Overvoltage protection	Latching type, recycle AC input to reset. OVP firing reduces output voltage to <50% of nominal in <50 mS. See "Ordering Information" for trip ranges.
Overtemperature protection	Automatic power shutdown at T _C = 155°C
Auxiliary Signals	
AC power fail	Stays HIGH during normal operation. Signal will go LOW with at least 5 mS warning before loss of DC output from AC failure.
DC OK	Open collector logic signal goes and stays HIGH, 100mS to 500mS after main output reaches regulation.
Inhibit	Connect to inhibit pin to output common to inhibit the DC output

ENVIRONMENTAL SPECIFICATIONS

Weight	210 grams
Dimensions	2.0" x 4.0" x 1.3" (W x L x H)
Vibration	Operating 0.003 g ² /Hz, 1.5 grms overall, 3 axes, 10 min/axis Non-operating 0.026 g ² /Hz, 5.0 grms overall, 3 axes, 1 hr/axis
Shock	Operating Half-sine, 20 gpk, 10 mS, 3 axes, 6 shocks total Non-operating Half-sine, 40 gpk, 10 mS, 3 axes, 6 shocks total
Operating temperature	-10°C to +70°C. Start up at -40°C, full load
Temperature derating	Derate output power linearly above 50°C to 50% at 70°C
Storage temperature	-40°C to +85°C
Altitude	Operating -500 to 10,000 ft Non-operating -500 to 40,000 ft
Relative humidity	5% to 95%, non-condensing

EMI/EMC COMPLIANCE

Conducted emissions	EN55011/22 Class B, FCC Part 15, Subpart B, Class B
Radiated emissions	EN55011/22 Class A, FCC Part 15, Subpart B, Class A w/6dB margin
Static discharge immunity	EN61000-4-2, 6 kV contact discharge, 8 kV air discharge, criteria A ¹
Radiated RF immunity	EN61000-4-3, 3 V/m, criteria A ¹
EFT/Burst immunity	EN61000-4-4, 2kV/5kHz, criteria A ¹
Line surge immunity	EN61000-4-5, 1 kV differential, 2 kV common mode, criteria A ¹
Conducted RF immunity	EN61000-4-6, 3 Vrms, criteria A ¹
Power frequency magnetic field immunity	EN61000-4-8, 3 A/m, criteria A ¹
Voltage dip immunity	EN61000-4-11, 0% Vin, 0.5 cycle; 40% Vin, 5 cycles; 70% Vin, 25 cycles; criteria A ¹
Line harmonic emissions	EN61000-3-2, class A,B,C & D
Flicker test	EN61000-3-3, Complies (dmax < 6%)

Notes:

1. According to the standards, performance criteria are decoded as following:
 - A. Normal performance during and after the test
 - B. Temporary degradation, self-recoverable
 - C. Temporary degradation, operator intervention required to recover the operation
 - D. Permanent damage

ORDERING INFORMATION

Model Number	Output Voltage	Maximum Load with Convection Cooling	Maximum Load with 200LFM Forced Air	Fan Output	Total Regulation	Ripple & Noise ²	OVP Threshold
MINT1175A1206K01	12 V	10.0 A	14.6 A	12 V/0.4 A	± 3%	1.2% pk-pk, 0.5% RMS	14.0 ± 1.1 V
MINT1175A1506K01	15 V	8.0 A	11.7 A	12 V/0.4 A	± 3%	1.0% pk-pk, 0.5% RMS	19.5 ± 1.5 V
MINT1175A2406K01	24 V	5.0 A	7.3 A	12 V/0.4 A	± 3%	1.2% pk-pk, 0.5% RMS	28.0 ± 2.5 V
MINT1175A4806K01	48 V	2.5 A	3.6 A	12 V/0.4 A	± 3%	1.0% pk-pk, 0.5% RMS	55.0 ± 4.0 V
MINT1175A5606K01	56 V	2.1 A	3.1 A	12 V/0.4 A	± 3%	1.0% pk-pk, 0.5% RMS	< 59.9 V

Notes:

1. Total convection power is 120 Watts.

2. Measured with noise probe directly across output terminals, and load terminated with 0.1 µF ceramic and 10 µF low ESR capacitors. All specifications are typical at 230 Vac, full load, at 25°C ambient unless noted.

3. Output adjustment on 56 V model will not exceed 56.2 V.

PIN ASSIGNMENTS

Connector	MINT1175	
J100 (Input connector)	PIN 1	AC Line
	PIN 2	SPARE
	PIN 3	AC Neutral
J300 (DC output connector)	PIN 1	+Vo
	PIN 2	+Vo
	PIN 3	+Vo
	PIN 4	-Vo
	PIN 5	-Vo
	PIN 6	-Vo
J500 (Fan output connector)	PIN 1	+12V Fan
	PIN 2	RTN
J600 (Signal connector)	PIN 1	Inhibit
	PIN 2	Power Fail/DC OK
	PIN 3	Common
	PIN 4	Common

CONNECTORS

	Connector	Mating Connector
J100 (Input connector)	/	MOLEX 09-50-3031. Pins = 08-52-0072
J300 (DC output connector)	/	AMP #640250-6. Pins = 640252-1
J500 (Fan Output Connector)	/	MOLEX 1375820-2. Pins = 1375819
J600 (Signal connector)	/	AMP #1375820-4. Pins = 1375819
J101 (Ground)	0.187" x 0.020" FASTON TAB	MOLEX 01-90020005 or equivalent

CONNECTORS

AC Power Failure/DC OK signal - J600:

During normal operation stays HIGH - goes HIGH, 100-500 mS after main output.
 - goes LOW, with 5 mS warning before loss of output from AC failure.

AC Power failure and DC OK Signals use the same pin, so the signals can be as follows:

DC OK: Pin 2 = High & Pin 1 = High

AC Power Failure: Pin 2 = Low & Pin 1 = Low

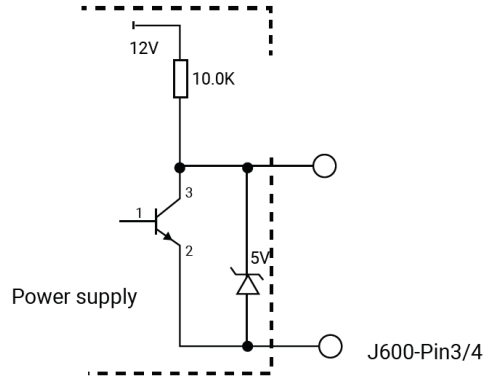

AC Inhibit Signals - J600:

Disable: Connect to output Common or pull down this pin below 10V

Enable: Floating or High (10.5V - 12.6V)

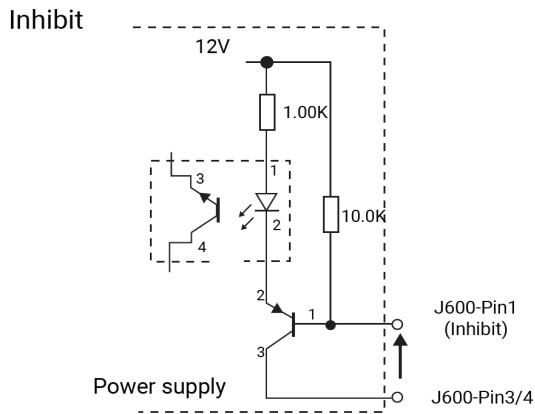

TIMING SEQUENCE

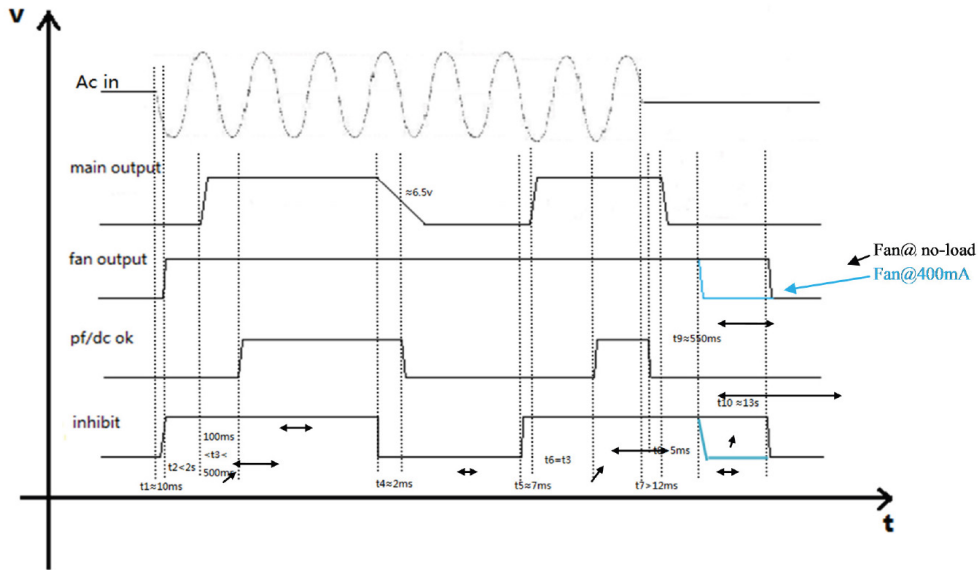

MECHANICAL DRAWING

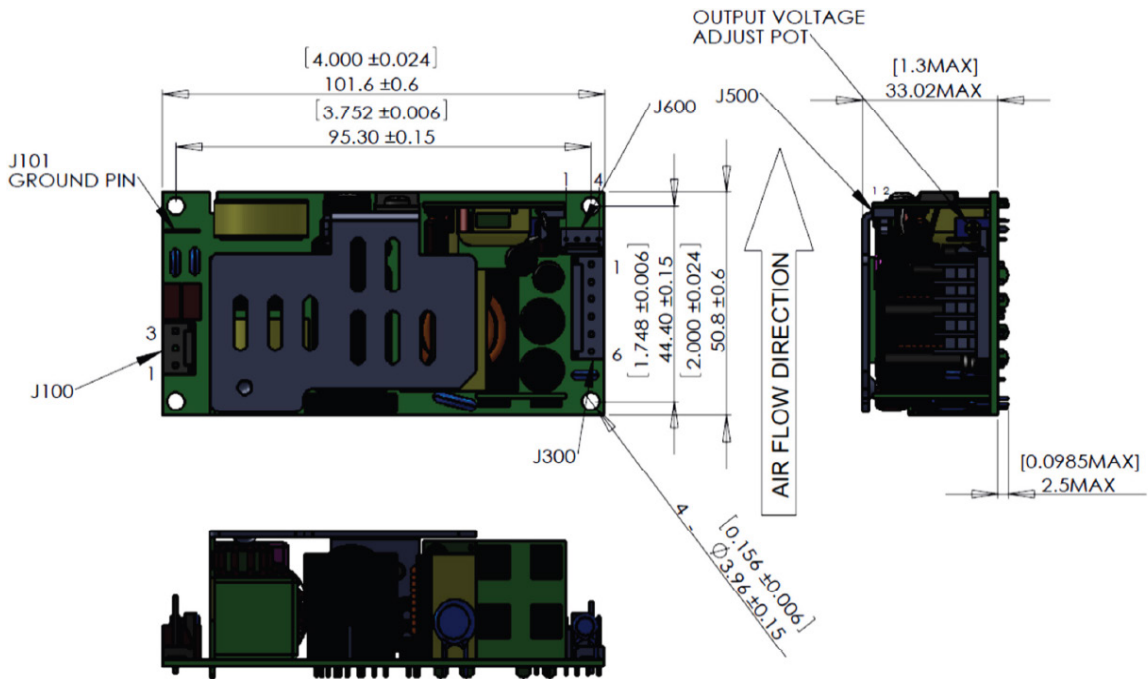

Notes:

1. All dimensions in inches (mm), tolerance is ± 0.02 ".
2. Mounting holes should be grounded for EMI purpose.
3. Mounting J101 is safety ground connection.
4. When installing the power supply into the end-product, a non-conductive insulator should be placed between the unit and any conductive metal chassis or mounting platform.

CHARACTERISTIC CURVES

Output vs. Temperature:

120 W convection cooled and 175 W continuous with 200 LFM airflow. Derate output power to 50% at 70°C.

Output Power vs. Temperature

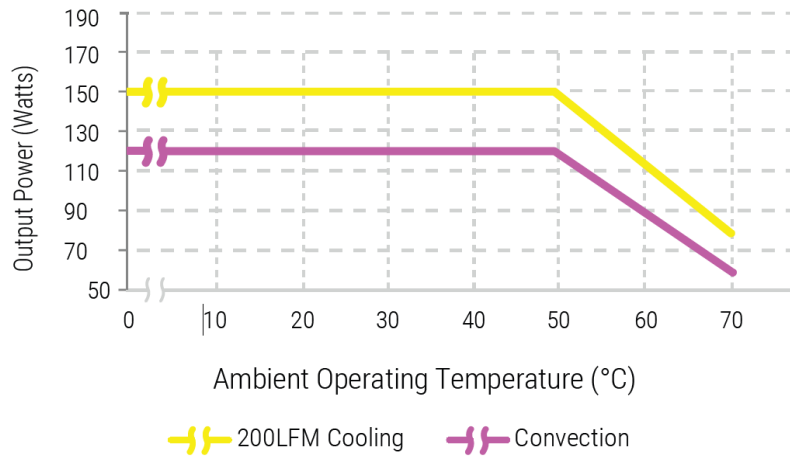

Efficiency vs. Loading:

The high efficiency is achieved by using LLC technology, PFC topology minimizing switching losses. Synchronous MOSFET or SCHOTTY diode is used as rectifier in MINT1175 series.

Efficiency vs. Output

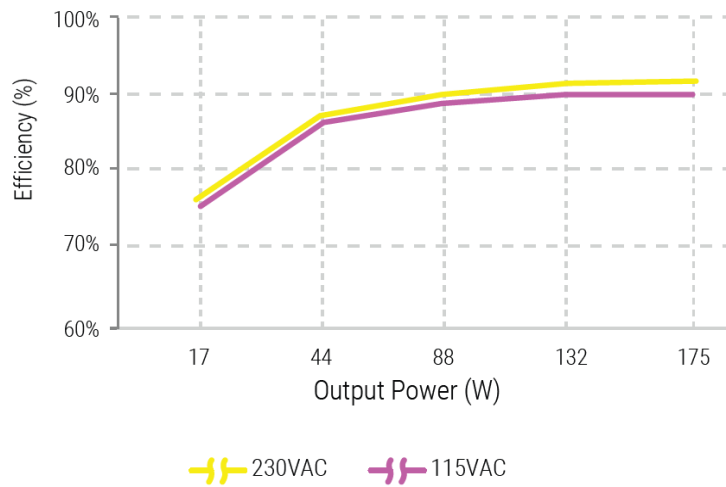

CHARACTERISTIC CURVES

Ripple vs. Noise:

To verify that the output ripple and noise does not exceed the level specified in the product specification. Measured using a scope probe socket with 0.1µF ceramic and a 10µF electrolytic capacitor connected in parallel across it, BW limit with 20MHz.

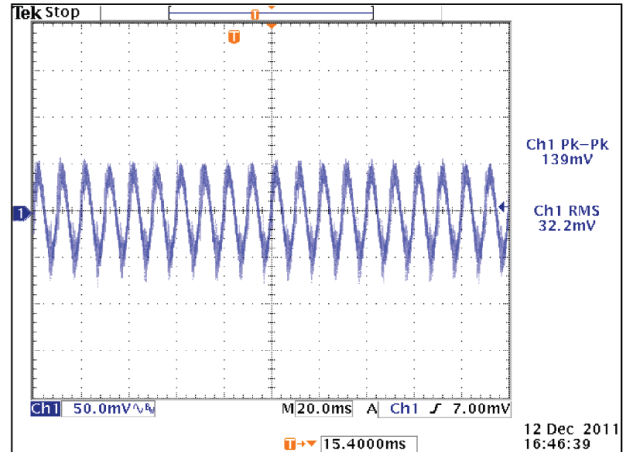
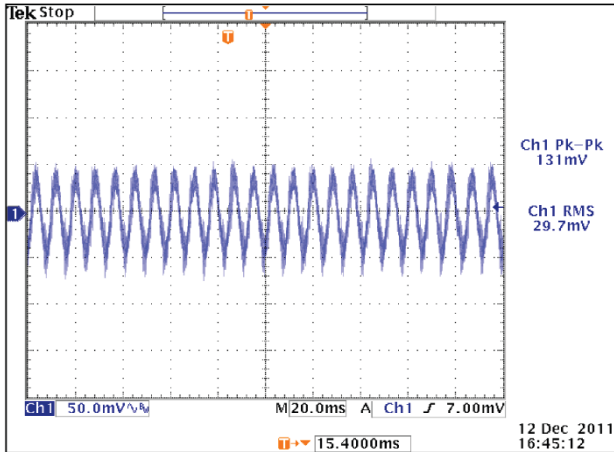

Output Transient Response:

50% load step within the regulation limits of minimum and maximum load, di/dt < 0.2 A/µs. Recovery time not specified as there is no laps in regulation with a 50% Load Step. Maximum voltage deviation is 3%.

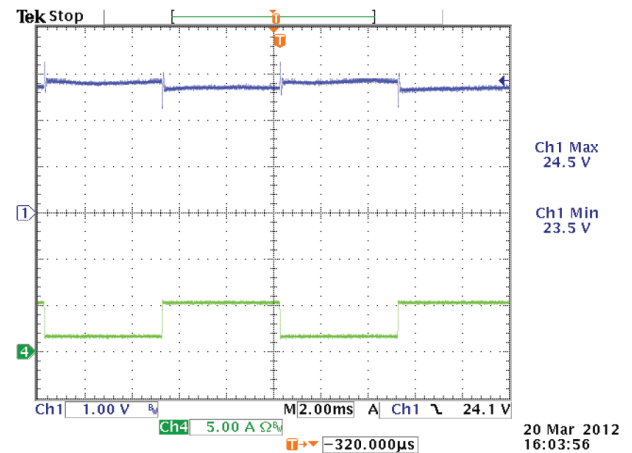
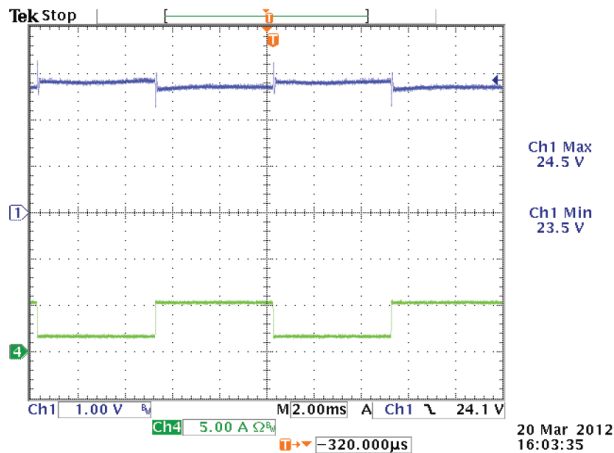

CHARACTERISTIC CURVES

Output Overload Characteristic:

Supply shall protect itself against overload condition. The power supply shall recover from overload conditions without operator intervention.

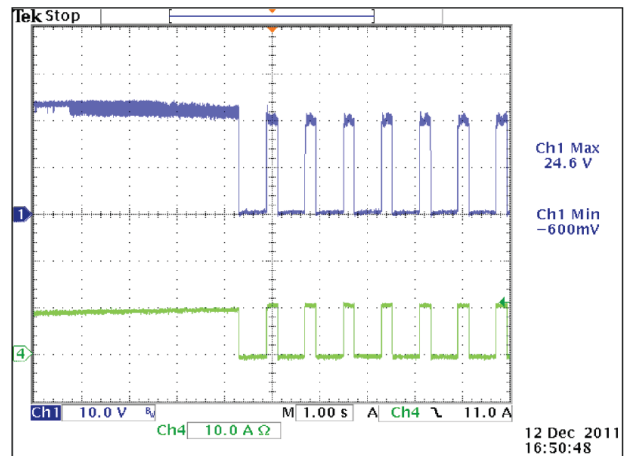
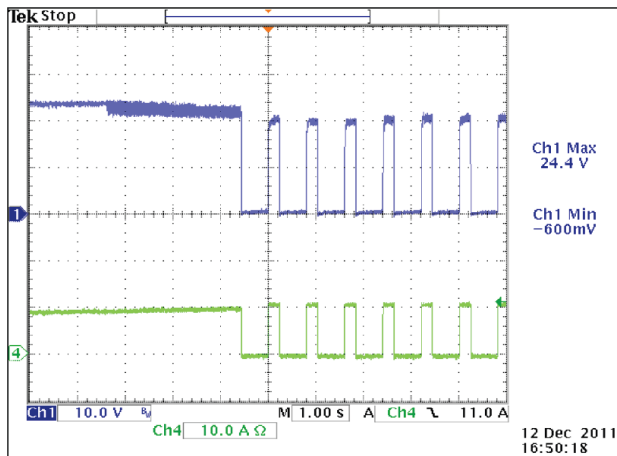

Output Overshoot:

When supply is turned on, off or when the load is stepped 100%, the power supply overshoot/undershoot shall not exceed minimum or maximum of output voltage regulation.

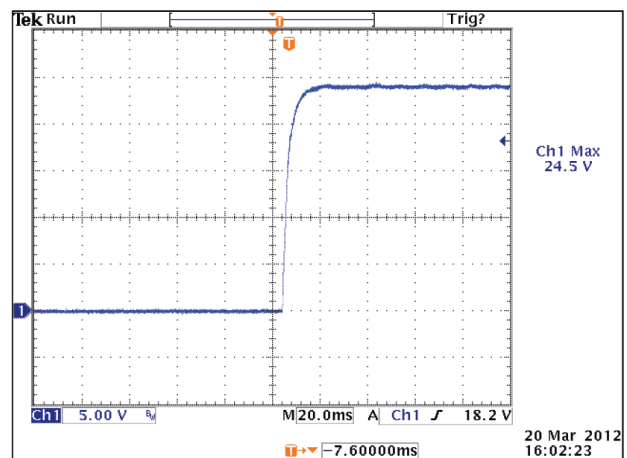
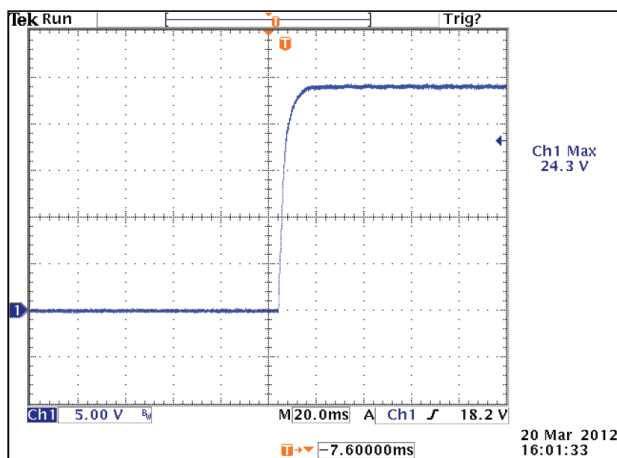



For international contact information,
visit [advancedenergy.com](https://www.advancedenergy.com).

powersales@aei.com (Sales Support)
productsupport.ep@aei.com (Technical Support)
+1 888 412 7832

ABOUT ADVANCED ENERGY

Advanced Energy (AE) has devoted more than three decades to perfecting power for its global customers. AE designs and manufactures highly engineered, precision power conversion, measurement and control solutions for mission-critical applications and processes.

Our products enable customer innovation in complex applications for a wide range of industries including semiconductor equipment, industrial, manufacturing, telecommunications, data center computing, and medical. With deep applications know-how and responsive service and support across the globe, we build collaborative partnerships to meet rapid technological developments, propel growth for our customers, and innovate the future of power.

PRECISION | POWER | PERFORMANCE | TRUST

Specifications are subject to change without notice. Not responsible for errors or omissions. ©2023 Advanced Energy Industries, Inc. All rights reserved. Advanced Energy®, and AE® are U.S. trademarks of Advanced Energy Industries, Inc.