

ARTESYN CPS250-M SERIES

250 W (forced air)
155 W (convection)

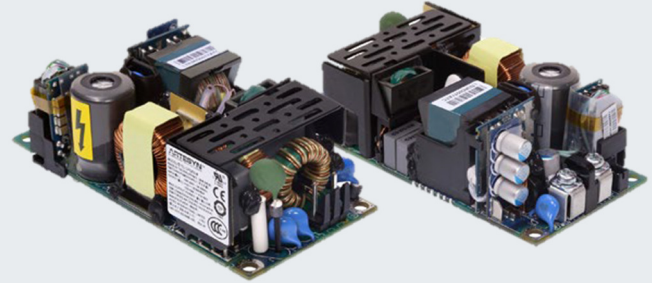

PRODUCT DESCRIPTION

Advanced Energy's Artesyn CPS250-M series power supply features a universal 90 to 264 Vac input and employs active power factor correction to minimize input harmonic current distortion and to ensure compliance with the international EN61000-3-2 standard. The power supply produces a tightly regulated main output and come with 12 Vdc fan output as standard. The main output can deliver up to 155 W continuously with convection cooling, or up to 250 W continuously with at least 300 LFM forced air cooling. The output can be adjusted up to +10% of nominal setpoint through trimpot.

SPECIAL FEATURES

- Designed for forced air and natural convection cooling
- Medical and ITE safety approvals, 2x MOPP
- Dual fused
- Type BF ready
- Active Power Factor Correction, 61000-3-2 compliant
- Built-in Class B EMI filter
- Less than 1U high
- LPX100 enclosure kit available
- <500 mW no-load power consumption
- Three-year warranty (consult factory for extended terms)
- RoHS 6 compliant

SAFETY

- | | |
|----------|-----------------------|
| ■ TUV | 62368-1 / 60601-1 |
| ■ UL/CSA | 62368-1 / 60601-1 |
| ■ CB | IEC 62368-1 / 60601-1 |
| ■ CE | LVD / RoHS |
| ■ CCC | Approval |
| ■ UKCA | Mark |

TYPICAL APPLICATIONS

- Industrial
- Medical

AT A GLANCE

Total Power

155 to 250 W

Input Voltage

90 to 264 Vac

of Outputs

Single



MODEL NUMBERS

Standard	Output Voltage	Minimum Load	Maximum Load Convection Cooling	Peak Load Convection Cooling ¹	Maximum Load Forced Air ²
CPS253-M	12 V	0 A	12.92 A	15.5 A	20.83 A
CPS255-M	24 V	0 A	6.45 A	7.74 A	10.42 A
CPS258-M	48 V	0 A	3.23 A	3.88 A	5.21 A

Note 1 - Peak Load current cannot exceed 30 S with maximum 10% duty cycle.

Note 2 - Requires at least 300 LFM of airflow.

Options

CPS253-M1 (Suffix "1" for optional features, please refer to Page 34 for more details).

ELECTRICAL SPECIFICATIONS

Absolute Maximum Ratings

Stress in excess of those listed in the “Absolute Maximum Ratings” may cause permanent damage to the power supply. These are stress ratings only and functional operation of the unit is not implied at these or any other conditions above those given in the operational sections of this TRN. Exposure to any absolute maximum rated condition for extended periods may adversely affect the power supply’s reliability.

Table 1. Absolute Maximum Ratings						
Parameter	Model	Symbol	Min	Typ	Max	Unit
Input Voltage AC continuous operation	All Models	$V_{IN,AC}$	90	-	264	Vac
Maximum Output Power (Main + Fan) Convection continuous operation	All Models	$P_{O,maxCC}$	-	-	155	W
Maximum Output Power (Main + Fan) Force air continuous operation	All Models	$P_{O,maxFA}$	-	-	250	W
Isolation Voltage ¹ Input to output Input to safety ground Outputs to output ground	All Models All Models All Models		- - -	- - -	5700 1500 1500	Vdc Vac Vac
Ambient Operating Temperature ²	All Models	T_A	-20	-	+70	°C
Cold Start-up Temperature ³	All Models	T_{ST}	-40	-	-	°C
Storage Temperature	All Models	T_{STG}	-40	-	+85	°C
Humidity (non-condensing) Operating Non-operating	All Models All Models		5 5	- -	90 95	% %
Altitude Operating	ITE Application Medical Application		0 0	- -	5000 3000	Meters Meters
Altitude Non-operating	All Models		0	-	16000	Meters

Note 1 - All Hi-pot testing will pass without removal of any components.

Note 2 - Please refer to Page 27 for derating from 50 °C to 70 °C.

Note 3 - -40 °C start up after a 5 minutes stabilization time before going to -20 °C. A start-up below -20 °C may result in instability but will not damage.

ELECTRICAL SPECIFICATIONS

Input Specifications

Table 2. Input Specifications						
Parameter	Condition	Symbol	Min	Typ	Max	Unit
Operating Input Voltage, AC ¹	All	$V_{IN,AC}$	90	115/230	264	Vac
Input AC Frequency ²	Medical Application $V_{IN,AC} = 110$ Vac	$f_{IN,AC}$	47 360	50/60 -	63 440	Hz
Maximum Input Current ($I_O = I_{O,maxFA}$)	$V_{IN,AC} = 90$ Vac	$I_{IN,max}$	-	-	3.5	A_{RMS}
No Load Input Power ($V_O = ON, I_O = 0$)	$V_{IN,AC} =$ 230 Vac @ 50 Hz or 115 Vac @ 60 Hz	$P_{IN,no-load}$	-	-	0.5	W
Harmonic Line Currents	All	THD	Per EN61000-3-2 Class A			
Power Factor ³	All	PF	0.9	-	-	
Startup Surge Current (Inrush) @ 25 °C	$V_{IN,AC} = 230$ Vac Cold start	$I_{IN,surge}$	-	-	70	A_{PK}
Input Fuse	Internal, L and N 250 Vac		-	-	6.3	A
Input AC Low Line Start-up Voltage		$V_{IN,AC-start}$	85	-	89	Vac
Input AC Undervoltage Lockout Voltage		$V_{IN,AC-stop}$	82	-	87	Vac
Efficiency @ 25 °C	$V_{IN,AC} = 230$ Vac	η	90	93	-	%
Hold Up Time	$V_{IN,AC} = 115 / 230$ Vac $P_O = 225$ W	$t_{Hold-Up}$	10	-	-	mS
Turn On Delay	$V_{IN,AC} = 100$ Vac	$t_{Turn-On}$	-	-	2	S
The Earth Leakage Current	Class I Class II $V_{IN} = 264$ Vac $f_{IN,AC} = 50/60$ Hz	$I_{IN,leakage}$	- -	- -	400 100	μA μA
Secondary Output Leakage Current	$V_{IN} = 264$ Vac $f_{IN,AC} = 50/60$ Hz	$I_{IN,leakage}$	-	-	100	μA
System Stability	Phase Margin Gain Margin All		45 10		- -	ϕ dB

Note 1 - Output load derating will apply for input voltage below 100 Vac.

Note 2 - The power supply will have higher leakage current when input frequency is 360 – 440 Hz.

Note 3 - Measured at 95 W input power and above.

ELECTRICAL SPECIFICATIONS

Output Specifications

Table 3. Output Specifications							
Parameter	Condition	Symbol	Min	Typ	Max	Unit	
Output Regulation	At 25 °C, including factory setpoint, Line voltage and Load current variations	%V _O	-2.0	-	+2.0	%	
Output Adjust Range ¹		%V _O	0	-	+10	%	
Output Ripple, pk-pk ²	CPS253-M CPS255-M CPS258-M	V _O	-	-	120	mV _{PK-PK}	
					240		
					480		
Convection Output Current, continuous	CPS253-M CPS255-M CPS258-M	Convection cooling	I _{O,maxCC}	-	-	12.92	A
	All models		I _{FAN,maxCC}	-	-	0.5	
	CPS253-M1		I _{SB,maxCC}	-	-	0.1	
Force Air Output Current, continuous	CPS253-M CPS255-M CPS258-M	300 LFM forced air cooling	I _{O,maxFA}	-	-	20.83	A
	All models		I _{FAN,maxFA}	-	-	0.5	
	CPS253-M1		I _{SB,maxFA}	-	-	0.1	
Output Current, peak	CPS253-M CPS255-M CPS258-M	Maximum duration of 30 S with maximum duty cycle of 10%	I _{O,peak}	-	-	15.5 7.74 3.88	A
V _O Overshoot / Undershoot ³		Tested with Maximum 330 uF/Amp capacitive load, CR mode, I _O ≤ 80% I _{O,max}	%V _O	-	-	7	%
Maximum Convection Output Power, continuous		Main output + fan output + Standby output	P _{O,maxCC}	-	-	155	W
Maximum Force air Output Power, continuous		Main output + fan output + Standby output , 400 LFM	P _{O,maxFA}	-	-	250	W
V _O Capacitive Load		Start up, CR load and capacitive load in parallel	-	0	-	330	μF/A
V _O Dynamic Response - Peak Deviation		50% (50% to 100% of I _{O,maxFA}) load change Output capacitance = 100 μF/A	±%V _O	-	-	4	%

Note 1 - The adjust pot is shown on page 21.

Note 2 - Minimum load required to meet 1% ripple requirement. More details please refer to Page35.

Note 3 - All output voltages must rise and fall in a monotonic fashion. Worst case (line and load) overshoot and undershoot shall be less than 7% or 150 mV whichever is greater with a minimum main output load of 150 mA or capacitive load of 100uF and a maximum capacitive load of 330 uF/A on the output tested on CR mode, 80% load max.

ELECTRICAL SPECIFICATIONS

Output Specifications

Table 3. Output Specifications Con't						
Parameter	Condition	Symbol	Min	Typ	Max	Unit
V _O Dynamic Response - Setting Time	50% (50% to 100% of I _{O,maxFA}) load change Output capacitance = 100 μF/A	t _s	-	-	500	μS
V _O Long Term Stability	Max change over 24 hours after thermal equilibrium (30 mins)	±%V _O	-	-	1.0	%
V _O Temperature Coefficient	V _{IN,AC} = 100Vac I _O = I _{O,max}	%V _O	-	-	0.04	%/ °C
V _O Over Voltage Protection	Latch off (AC recycle to reset)	%V _O	130	-	150	%
V _O Over Current Protection						
Free-Air Convection	All	%I _O	120	-	150	%
Forced-Air Cooling			103	-	120	%
Over Temperature Protection	All		Auto Recovery			
Short Circuit Protection	All		Auto Recovery			
DC-DC Switching Frequency	All	f _{SW,DC-DC}	-	108	-	KHz

ELECTRICAL SPECIFICATIONS

CPS253-M1 Performance Curves

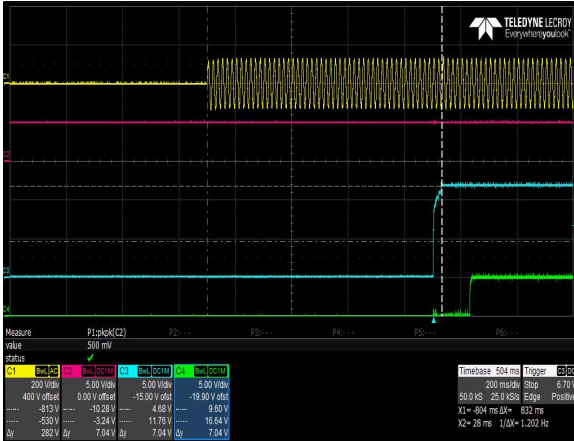

Figure 1: CPS253-M1 Turn-on delay via AC mains
 Vin = 90 Vac Load: Io = 18.75 A (forced air)
 Ch 1: V_{IN} Ch 2: Inhibit Ch 3: V_O Ch 4: DCOK

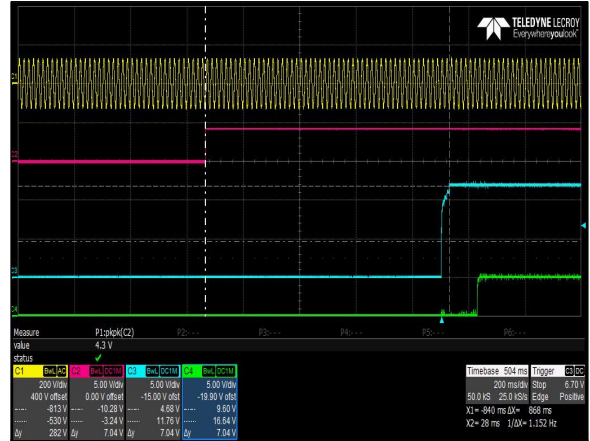

Figure 2: CPS253-M1 Turn-on delay via Remote Inhibit
 Vin = 90 Vac Load: Io = 18.75 A (forced air)
 Ch 1: V_{IN} Ch 2: Inhibit Ch 3: V_O Ch 4: DCOK

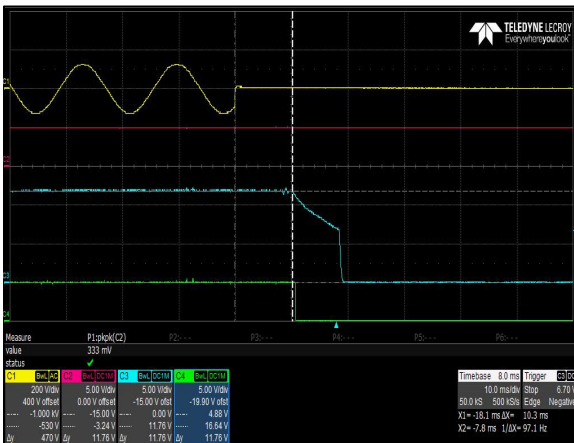

Figure 3: CPS253-M1 Hold-up Time
 Vin = 90 Vac Load: Io = 18.75 A (forced air)
 Ch 1: V_{IN} Ch 2: Inhibit Ch 3: V_O Ch 4: DCOK

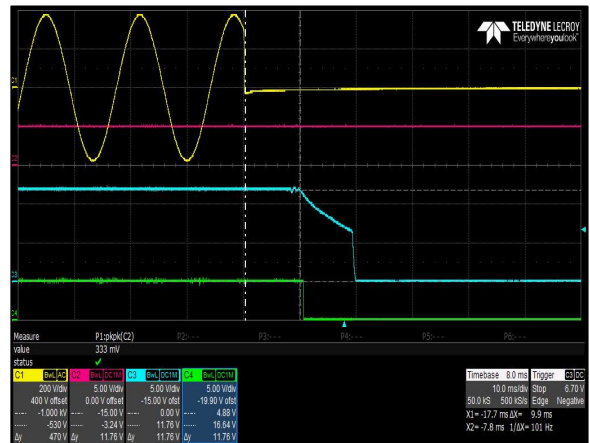

Figure 4: CPS253-M1 Hold-up Time
 Vin = 264 Vac Load: Io = 20.83 A (forced air)
 Ch 1: V_{IN} Ch 2: Inhibit Ch 3: V_O Ch 4: DCOK

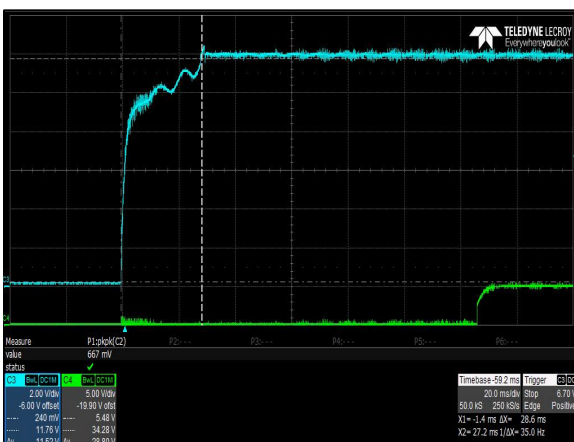

Figure 5: CPS253-M1 Output Voltage Startup Characteristic
 Vin = 90 Vac Load: Io = 18.75 A (forced air)
 Ch 1: V_{IN} Ch 2: DCOK

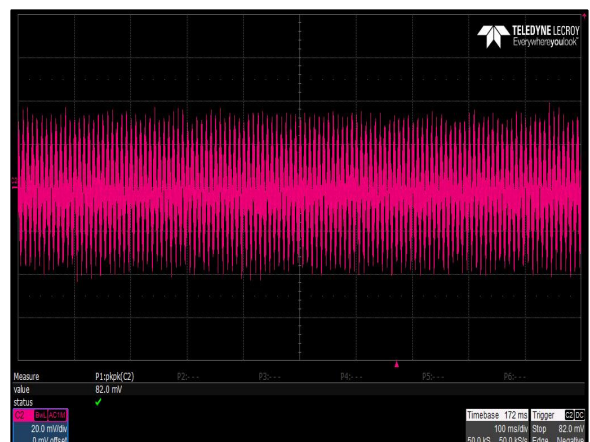

Figure 6: CPS253-M1 Ripple and Noise Measurement
 Vin = 115 Vac Load: Io = 20.83 A (forced air)
 Ch 2: V_O

ELECTRICAL SPECIFICATIONS

CPS253-M1 Performance Curves

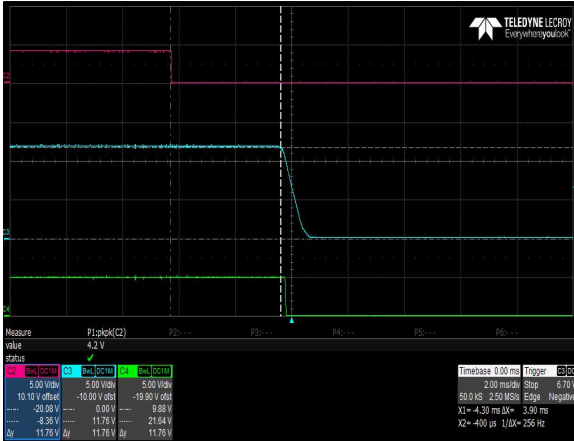

Figure 7: CPS253-M1 Turn Off Characteristic via Remote Inhibit
 Vin = 115 Vac Load: I_o = 20.83 A (forced air)
 Ch 2: Inhibit Ch 3: V_O Ch 4: DCOK

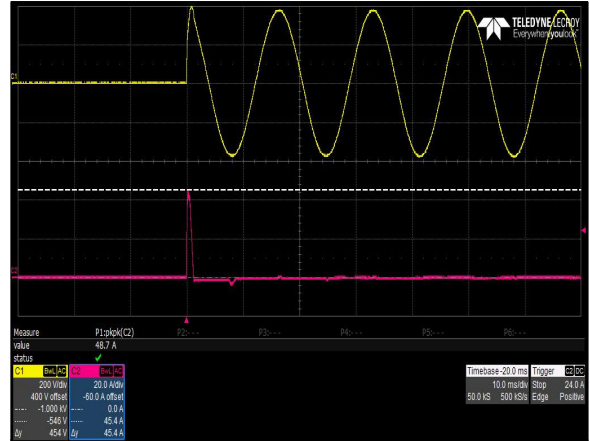

Figure 8: CPS253-M1 Inrush Current
 Vin = 264 Vac Load: I_o = 0 A, Turn on Angle = 90 deg
 Ch 1: V_{IN} Ch 3: I_{IN}

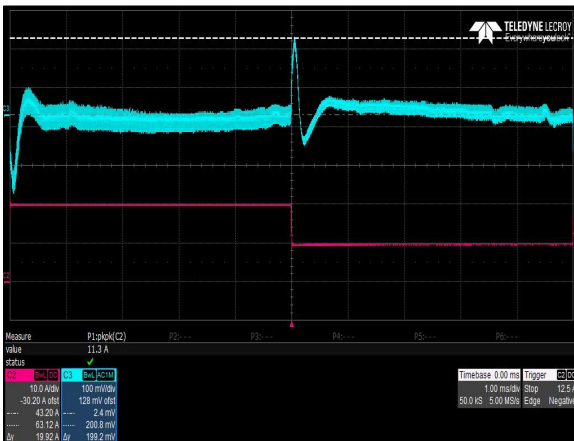

Figure 9: CPS253-M1 Transient Response - V_o Deviation
 Vin = 115 Vac Load: I_o = 100% to 50% load change, 1 A/us
 Ch 2: I_o Ch 3: V_o

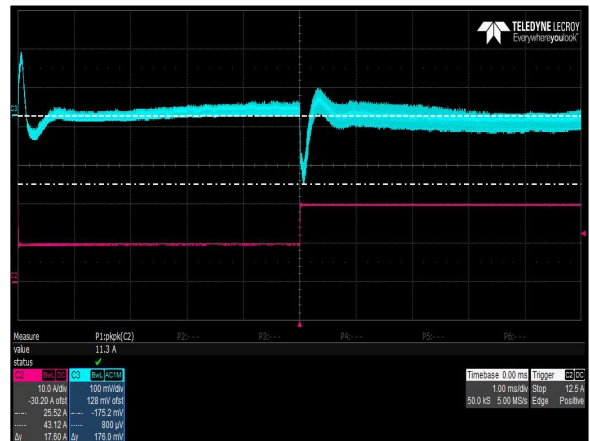

Figure 10: CPS253-M1 Transient Response - V_o Deviation
 Vin = 115 Vac Load: I_o = 50% to 100% load change, 1 A/us
 Ch 2: I_o Ch 3: V_o

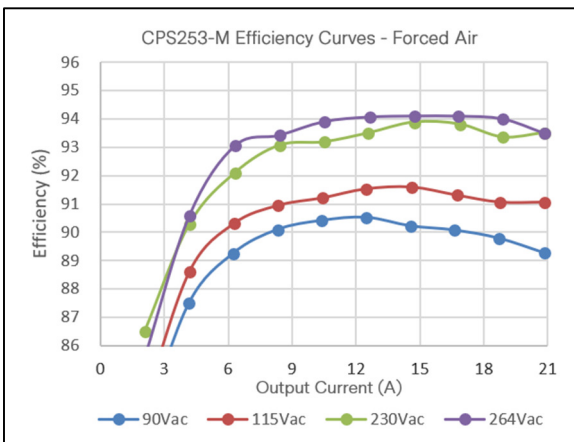

Figure 11: CPS253-M Efficiency Curves @ Room Temp.
 Forced Air Cooling
 V_{IN} = 90 to 264 Vac Load: I_o = 10% increment to 20.83 A

ELECTRICAL SPECIFICATIONS

CPS255-M Performance Curves

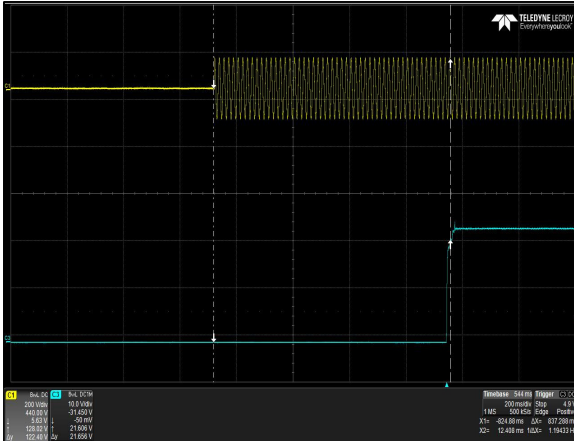

Figure 12: CPS255-M Turn-on delay via AC mains
 Vin = 90 Vac Load: Io = 9.38 A (forced air)
 Ch 1: VIN Ch 3: VO

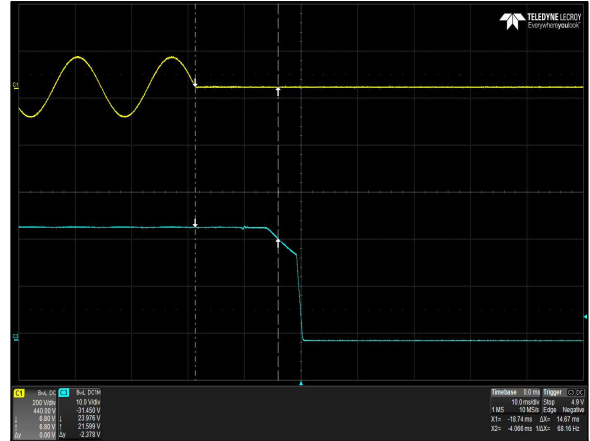

Figure 13: CPS255-M Hold-up Time
 Vin = 90 Vac Load: Io = 9.38 A (forced air)
 Ch 1: VIN Ch 3: VO

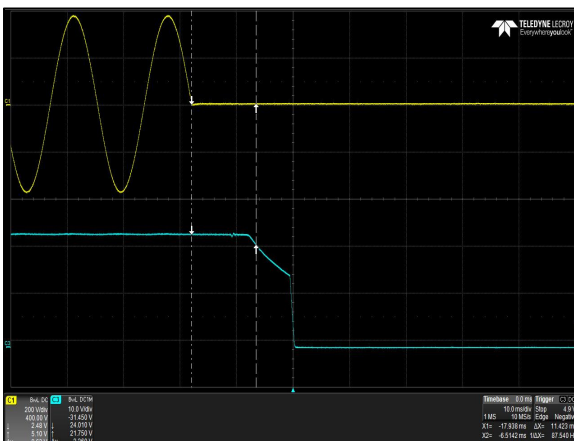

Figure 14: CPS255-M Hold-up Time
 Vin = 264 Vac Load: Io = 10.42 A (forced air)
 Ch 1: VIN Ch 3: VO

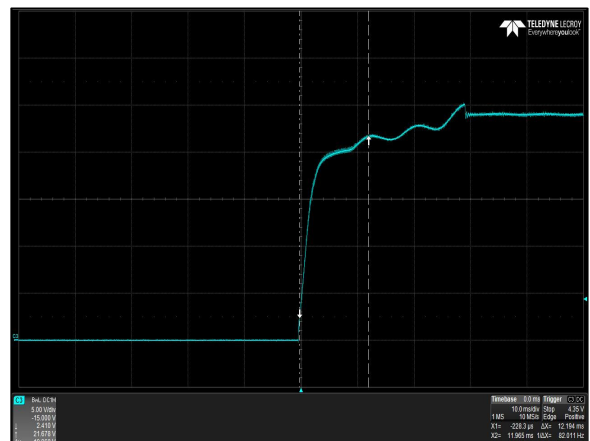

Figure 15: CPS255-M Output Voltage Startup Characteristic
 Vin = 90 Vac Load: Io = 9.38 A (forced air)
 Ch 3: VO

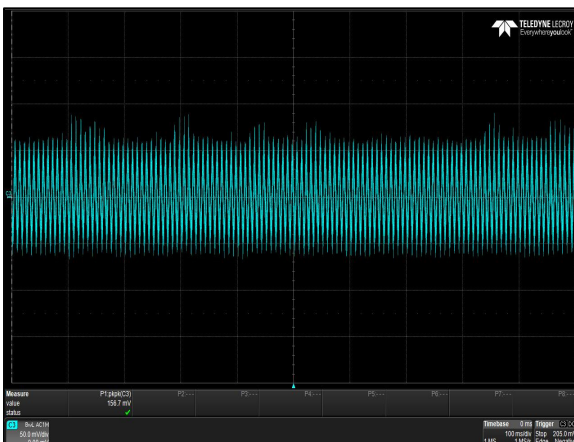

Figure 16: CPS255-M Ripple and Noise Measurement
 Vin = 115 Vac Load: Io = 10.42 A (forced air)
 Ch 3: VO

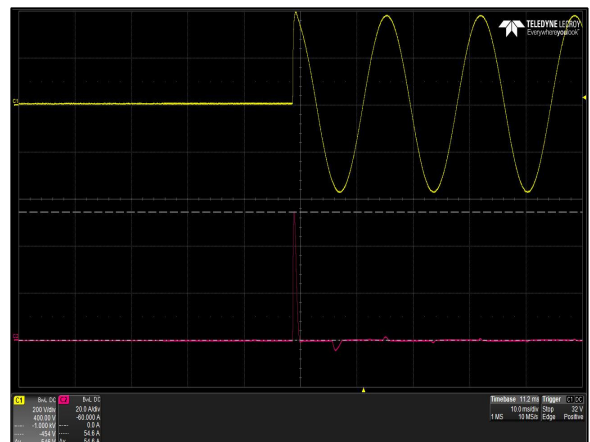

Figure 17: CPS255-M Inrush Current
 Vin = 264 Vac Load: Io = 0 A, Turn on Angle = 90 deg
 Ch 1: VIN Ch 3: IIN

ELECTRICAL SPECIFICATIONS

CPS255-M Performance Curves

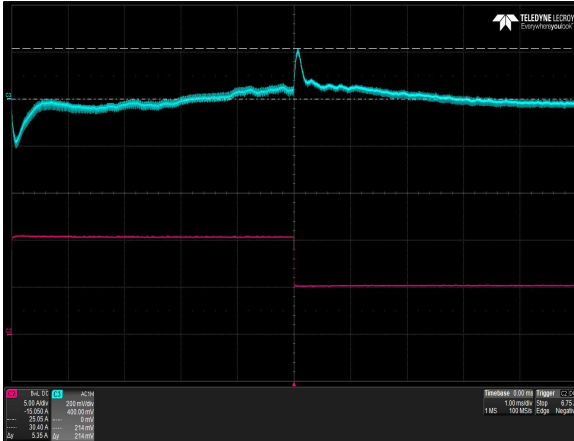

Figure 18: CPS255-M Transient Response - Vo Deviation
 Vin = 115 Vac Load: Io = 100% to 50% load change, 1 A/us
 Ch 2: Io Ch 3: Vo

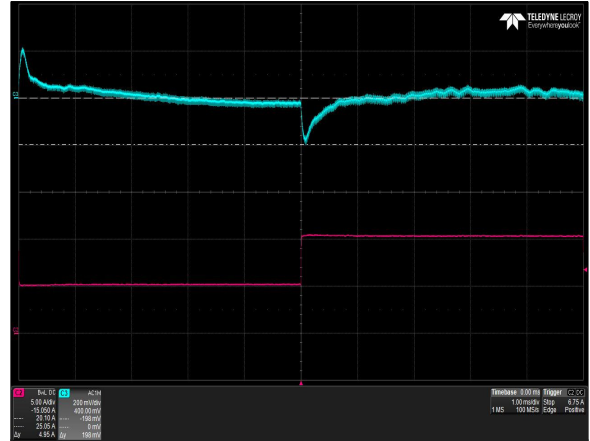

Figure 19: CPS255-M Transient Response - Vo Deviation
 Vin = 115 Vac Load: Io = 50% to 100% load change, 1 A/us
 Ch 2: Io Ch 3: Vo

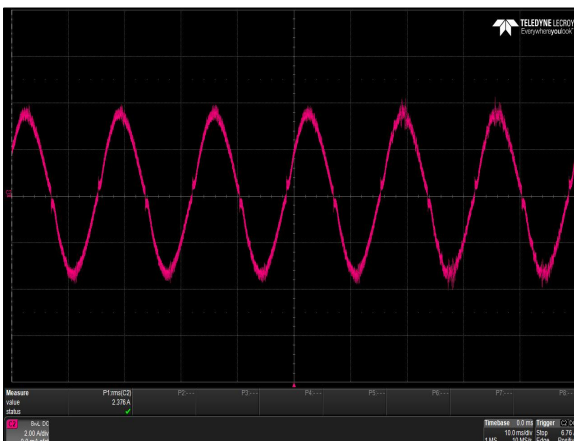

Figure 20: CPS255-M Input Current
 Vin = 115 Vac Load: Io = 10.42 A (forced air)
 Ch 2: Io

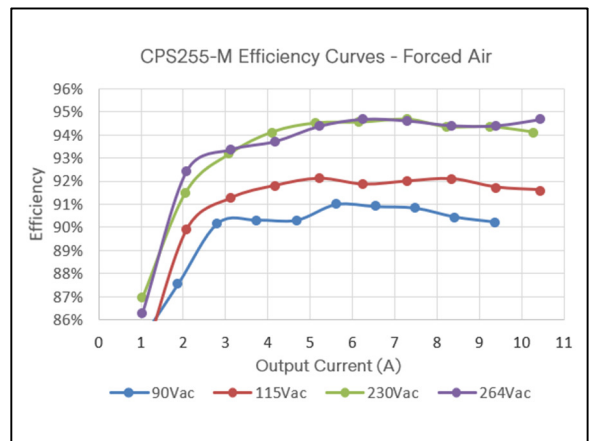

Figure 21: CPS255-M Efficiency Curves @ Room Temp.
 Forced Air Cooling
 Vin = 90 to 264 Vac Load: Io = 10% increment to 10.42 A

ELECTRICAL SPECIFICATIONS

CPS258-M Performance Curves

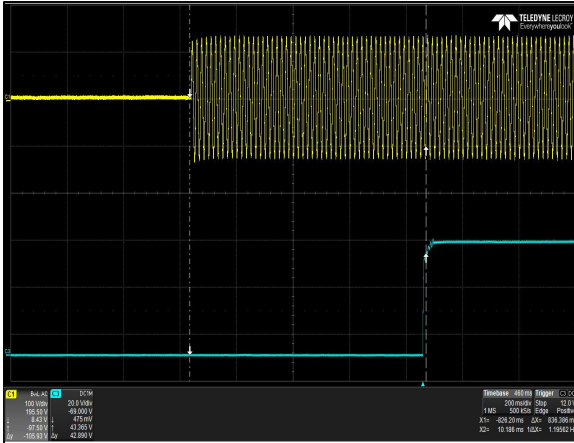

Figure 22: CPS258-M Turn-on delay via AC mains
 Vin = 90 Vac Load: Io = 4.69 A (forced air)
 Ch 1: V_{IN} Ch 3: V_O

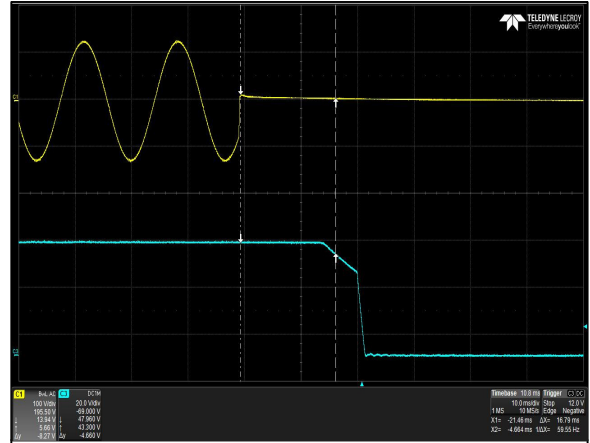

Figure 23: CPS258-M Hold-up Time
 Vin = 90 Vac Load: Io = 4.69 A (forced air)
 Ch 1: V_{IN} Ch 3: V_O

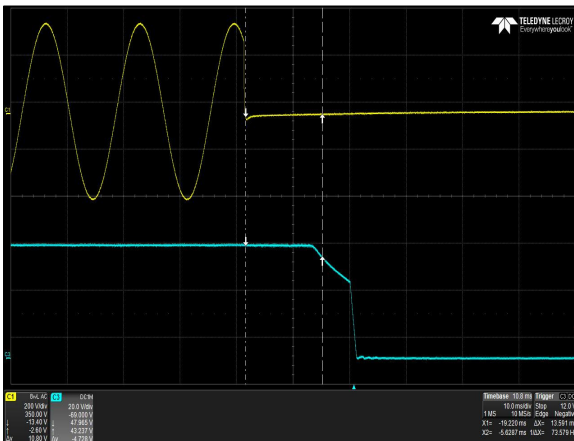

Figure 24: CPS258-M Hold-up Time
 Vin = 264 Vac Load: Io = 5.21 A (forced air)
 Ch 1: V_{IN} Ch 3: V_O

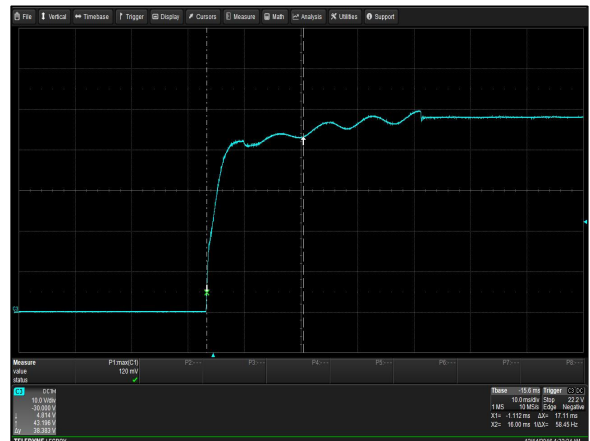

Figure 25: CPS258-M Output Voltage Start-up Characteristic
 Vin = 90 Vac Load: Io = 4.69 A (forced air)
 Ch 3: V_O

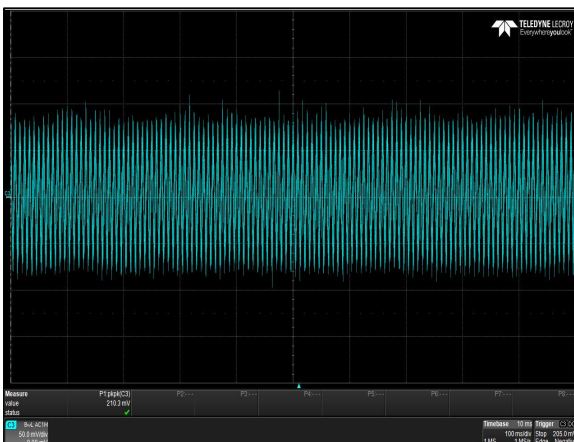

Figure 26: CPS258-M Ripple and Noise Measurement
 Vin = 115 Vac Load: Io = 5.21 A (forced air)
 Ch 3: V_O

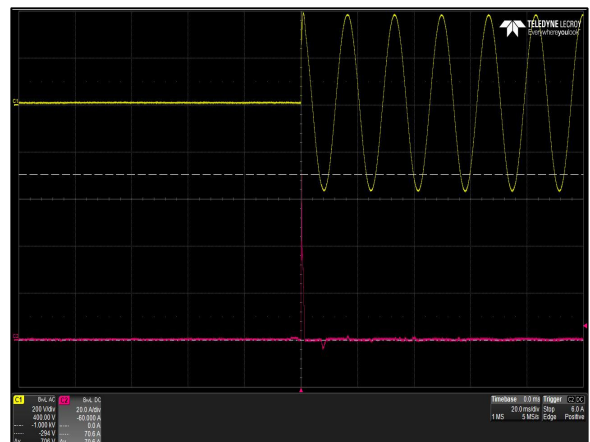

Figure 27: CPS258-M Inrush Current
 Vin = 264 Vac Load: Io = 0 A, Turn on Angle = 90 deg
 Ch 1: V_{IN} Ch 3: I_{IN}

ELECTRICAL SPECIFICATIONS

CPS258-M Performance Curves

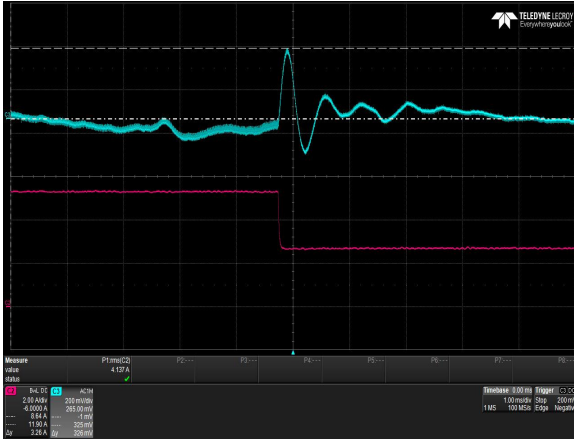

Figure 28: CPS258-M Transient Response - Vo Deviation
 Vin = 115 Vac Load: Io = 100% to 50% load change, 1 A/us
 Ch 2: Io Ch 3: Vo



Figure 29: CPS258-M Transient Response - Vo Deviation
 Vin = 115 Vac Load: Io = 50% to 100% load change, 1 A/us
 Ch 2: Io Ch 3: Vo

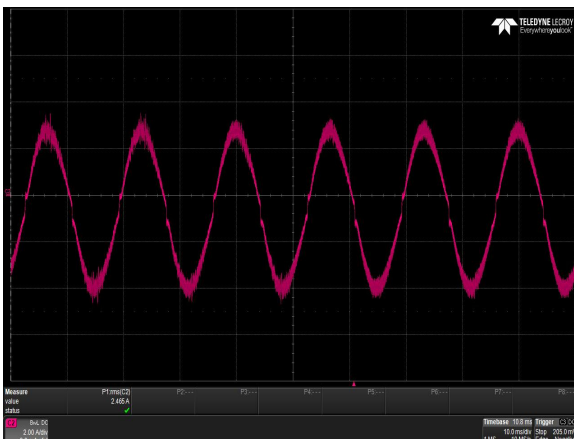

Figure 30: CPS258-M Input Current
 Vin = 115 Vac Load: Io = 5.21 A(forced air)
 Ch 2: IIN

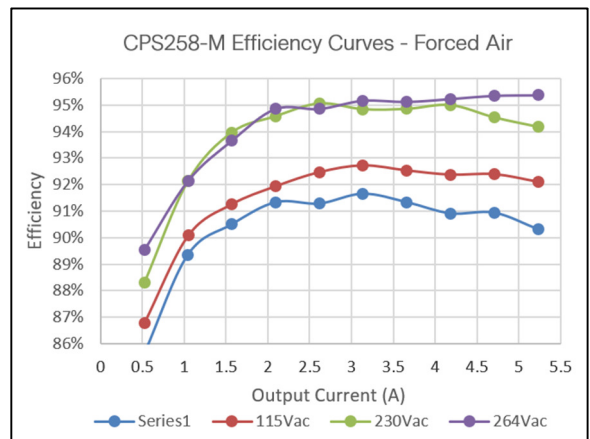

Figure 31: CPS258-M Efficiency Curves @ Room Temp.
 Forced Air Cooling
 VIN = 90 to 264 Vac Load: Io = 10% increment to 5.21 A

ELECTRICAL SPECIFICATIONS

Protection Function Specifications

Input Fuse

CPS250-M series power supply has protective Fuses on both the “Line” and “Neutral” side of the primary line. Fuse spec is 250 Vac and 6.3 A.

Over Voltage Protection (OVP)

The CPS250-M series power supply main output will latch off during output overvoltage. It requires an AC line recycle to reset the output.

CPS253-M

Parameter	Min	Typ	Max	Unit
V _O Output Overvoltage	15.6	/	18.0	V

CPS255-M

Parameter	Min	Typ	Max	Unit
V _O Output Overvoltage	31.2	/	36.0	V

CPS258-M

Parameter	Min	Typ	Max	Unit
V _O Output Overvoltage	62.4	/	72.0	V

Short Circuit Protection (SCP)

The power supply will withstand a continuous short circuit with no permanent damage. The power supply will automatically restart when the short circuit is removed. A short is defined as impedance less than 50 milliohms. The SCP mode is hiccup.

Over Temperature Protection (OTP)

The power supply will shut down during over-temperature condition and return back to normal operation when the power supply is cooled down (including hysteresis). The CPS250-M series power supply might experience over-temperature conditions during a persistent overload on the output. Overload conditions can be caused by external faults. OTP might also be entered due to a loss of control of the environmental conditions e.g. an increase in the converter's ambient temperature due to a failing fan or external cooling system etc.

ELECTRICAL SPECIFICATIONS

Protection Function Specifications

Over Current Protection (OCP)

The CPS250-M series power supply includes internal current limit circuitry to prevent damage in the event of overload or short circuit. The OCP mode is hiccup. Recovery is automatic when the overload is removed. The customer have access to the OCP potentiometer to set it for Forced Air condition or Free-Air Convection Rating. Please refer to Page 30 for more details.

The OCP range under Free-Air Convection cooling is 120% to 150%. (typical setting is at 135%). The OCP range under Forced-Air cooling 103% to 120% (typical setting is 110%). The OCP level does not vary linearly but rather 2 settings only and is either forced air or convection limits.

CPS253-M

Parameter	Min	Typ	Max	Unit
V _O Output Overcurrent (Free-Air cooling)	15.50	/	19.38	A
V _O Output Overcurrent (Forced-Air cooling)	21.45	/	25.00	A

CPS255-M

Parameter	Min	Typ	Max	Unit
V _O Output Overcurrent (Free-Air cooling)	7.74	/	9.68	A
V _O Output Overcurrent (Forced-Air cooling)	10.73	/	12.50	A

CPS258-M

Parameter	Min	Typ	Max	Unit
V _O Output Overcurrent (Free-Air cooling)	3.88	/	4.85	A
V _O Output Overcurrent (Forced-Air cooling)	5.37	/	6.25	A

MECHANICAL SPECIFICATIONS

Mechanical Outlines (CPS253-M Variant; unit: mm)

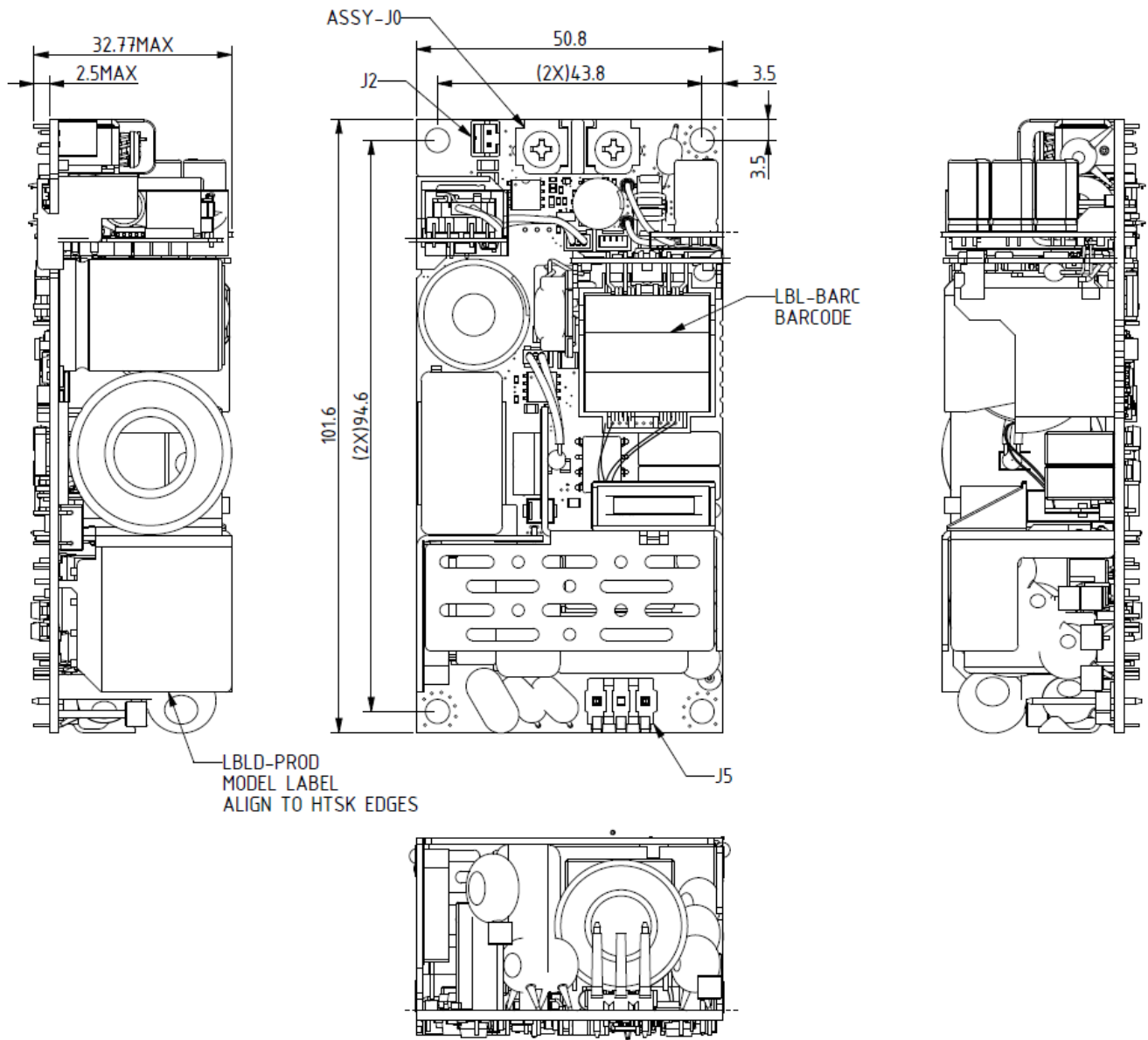

MECHANICAL SPECIFICATIONS

Mechanical Outlines (CPS253-M1 Variants; unit: mm)

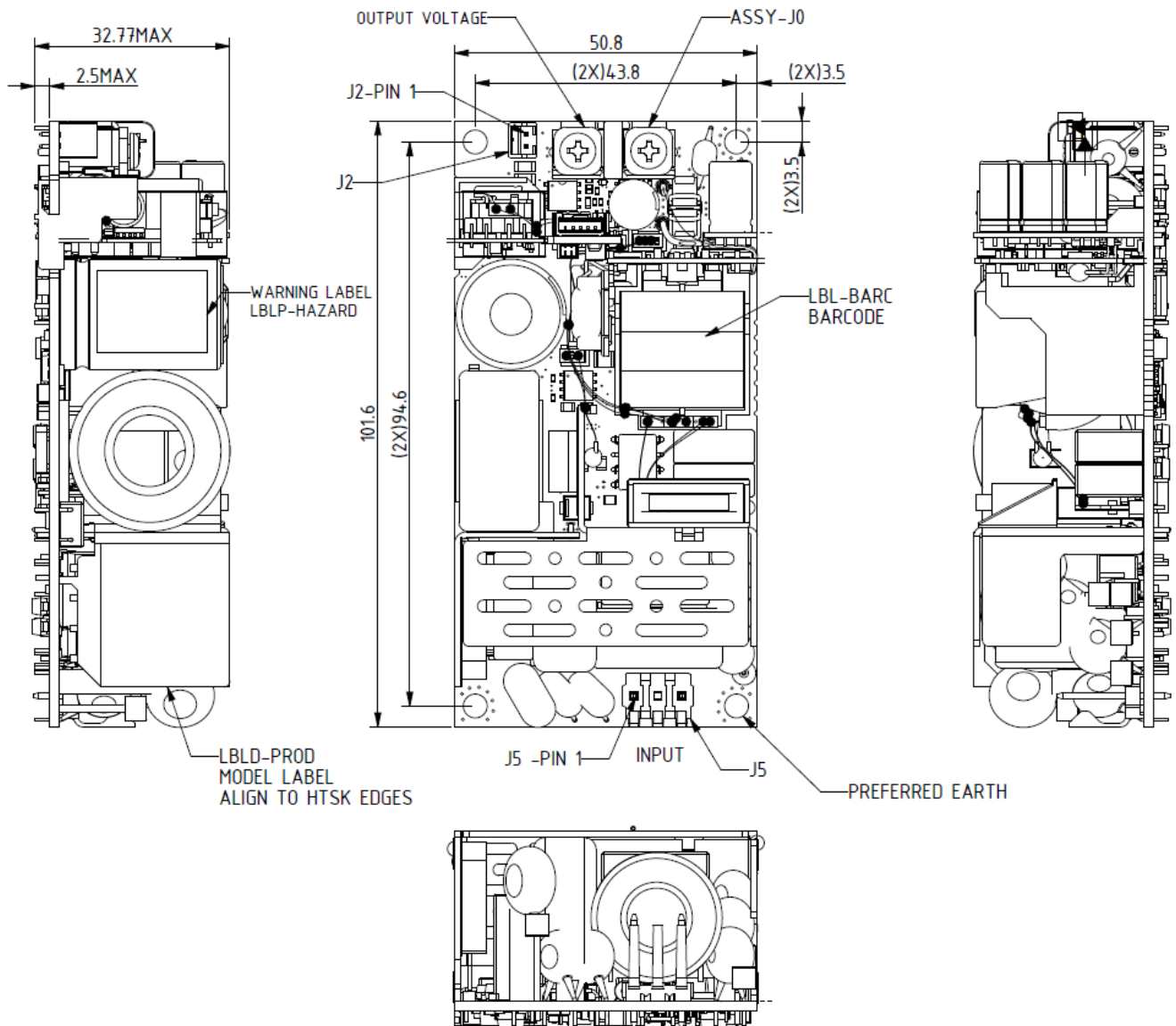

MECHANICAL SPECIFICATIONS

Mechanical Outlines (24 V and 48 V Variants; unit: mm)

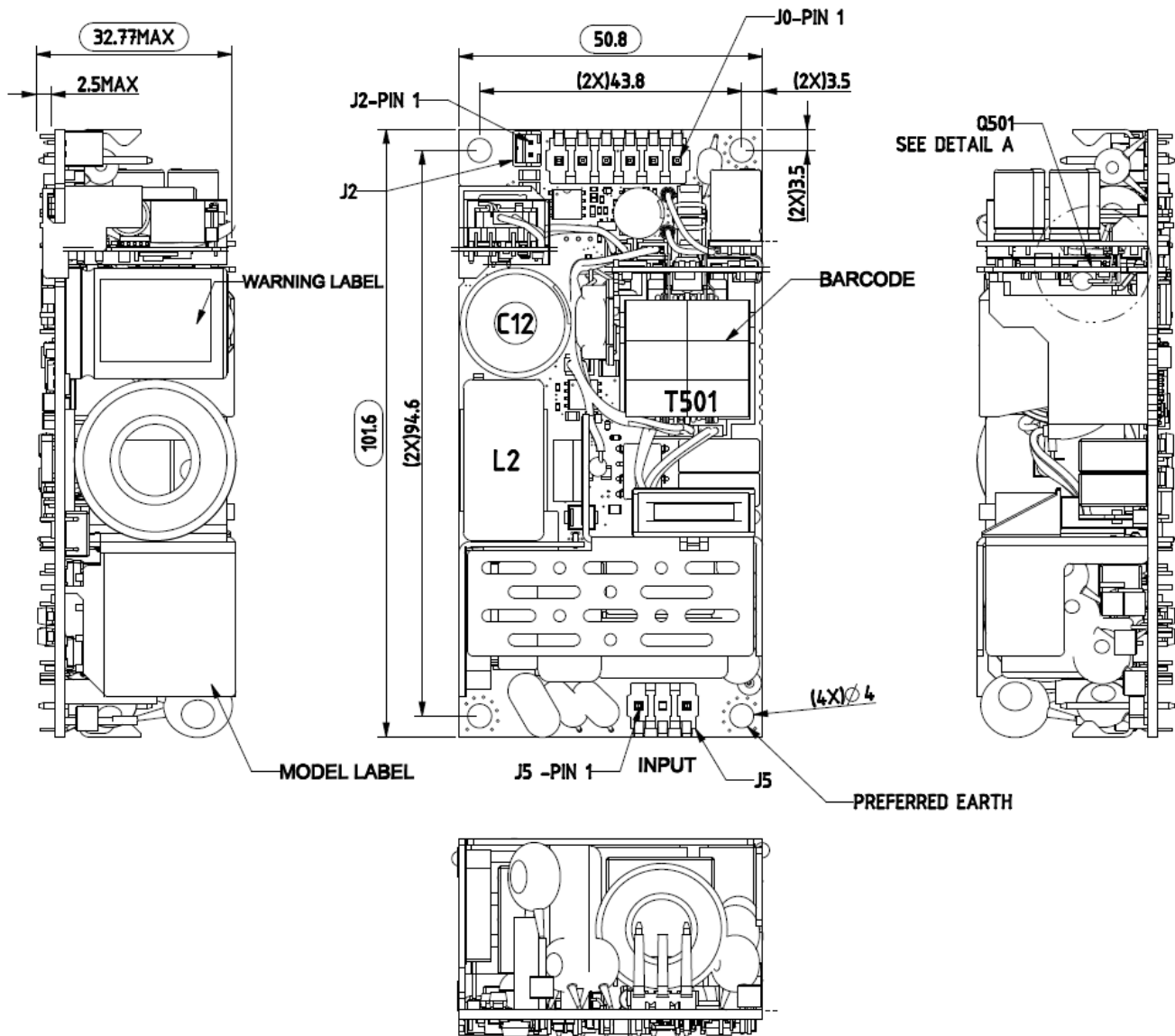

MECHANICAL SPECIFICATIONS

Mechanical Outlines (Enclosure Kit: LPX100; unit: mm)

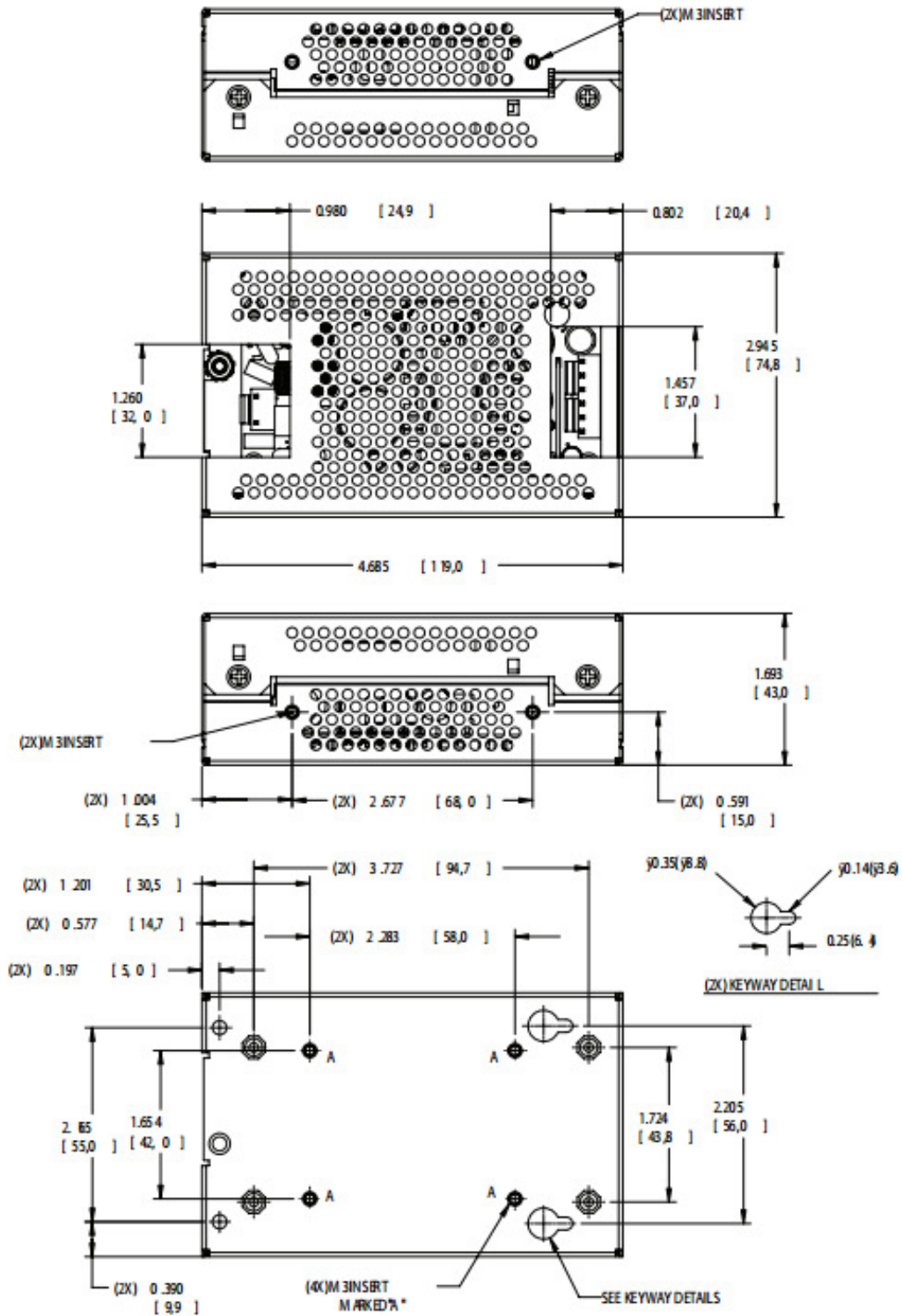

MECHANICAL SPECIFICATIONS

Connector Definitions

AC Input Connector - J5

Pin 1 - Line

Pin 3 - Neutral

Mounting Holes - PE

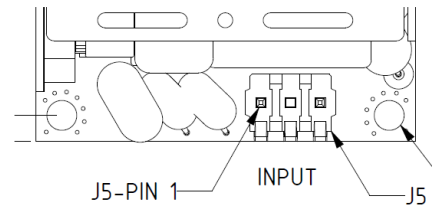

Output Connector - J0 (12 V Variant)

Barr1 - Main Output

Barr2 - Main Output Return

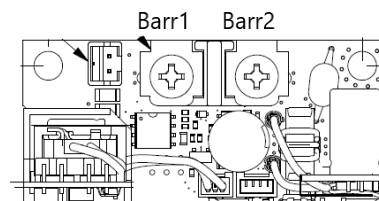

Output Connector - J0 (Other Variants)

Pin 1-3 - Main Output Return

Pin 4-6 - Main Output

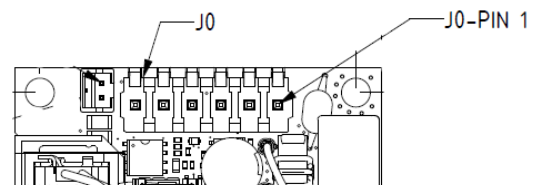

12 V Fan Supply Header - J2

Pin 1 - Fan Return

Pin 2 - Fan Voltage

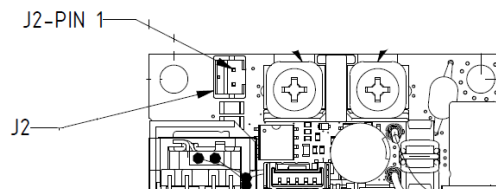

Control Signal Header – CPS253-M1 only

Pin 1 - 5 Vdc Standby

Pin 2 - Standby Return

Pin 3 - Remote Inhibit

Pin 4 - DC OK

Pin 5 - VFB (feedback loop pin)

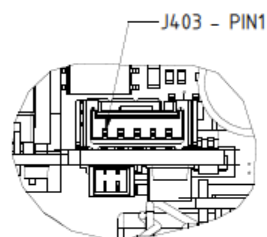

MECHANICAL SPECIFICATIONS

Power / Signal Mating Connectors and Pin Types

Table 4. Mating Connectors for CPS250-M Series	
Reference	Mating Connector or Equivalent
J5: AC Input	Molex 09-50-8031 or equivalent (housing); Molex 45570-3000 (crimp); AWG 20-18 wires.
J0: DC Output (12 V Variant)	Ring terminal: Tyco 35148 or KST RV3-4 or equivalent.
J0: DC Output (24 V, 48 V Variants)	Molex 09-50-8061 or equivalent (housing); Molex 45570-3000 (crimp); AWG 20-18 wires.
J2: Fan Output	Cvilux CI0102S0000 (housing); CI01T01MPP0 (crimp); AWG 30-24 wires.
J403: Control Signals (CPS253 -M1 models only)	Molex 504193-0500 (housing); Molex 504185-1000 (crimp); AWG 30-26 wires.
J5: AC Input	Molex 09-50-8031 or equivalent (housing); Molex 45570-3000 (crimp); AWG 20-18 wires.

MECHANICAL SPECIFICATIONS

Potentiometer Definitions

VR1 – Main output voltage adjustment

VR1 Location for Output Adjust

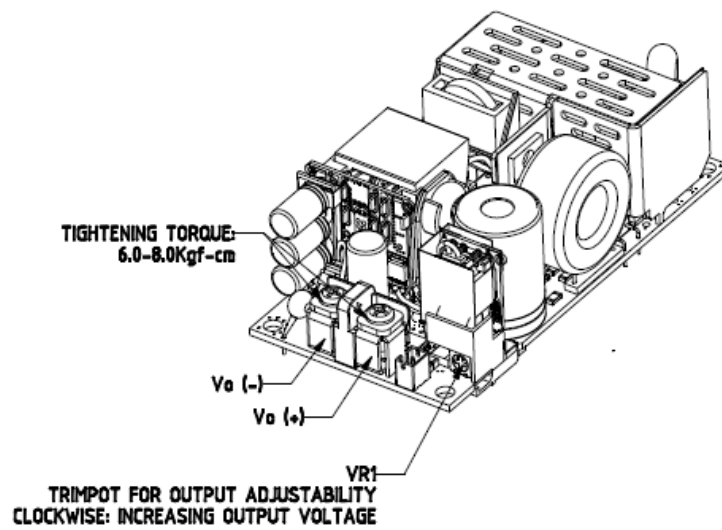

VR2 – OCP Limit Adjustment

VR2 Location for Setting Unit to Natural Convection (155 W max) or Forced Air Cooling (250 W max) operation

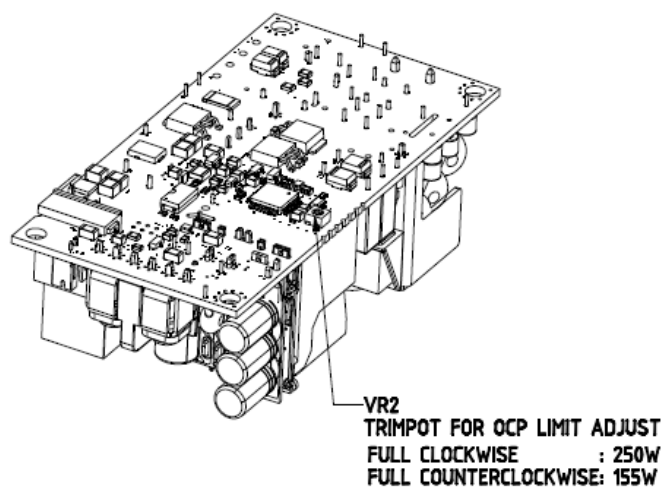

MECHANICAL SPECIFICATIONS

Weight

The CPS250-M series weight is 0.44 lb / 200 g maximum.

ENVIRONMENTAL SPECIFICATIONS

EMC Immunity

CPS250-M series power supply is designed to meet the following EMC immunity specifications.

Table 5. Environmental Specifications											
Document	Description										
EN 61000-4-2	ESD up to 15 KV air contact, 8 KV contact discharge, Criteria A, no enclosure preferred, but with LPX100 enclosure if necessary.										
EN 61000-4-3	Radiated Immunity 10 V/m, Criteria A.										
EN 61000-4-4	Electrical Fast Transients level 3 minimum, 100 kHz rate, Criteria A.										
EN 61000-4-5	Surge level 3 minimum, Criteria A.										
EN 61000-4-6	Radio frequency common mode, Levels 3 V (rms), Modulated AM 80%, 1 kHz, 150 ohm source impedance, Criteria A.										
EN 61000-4-8	Power Frequency Magnetic Immunity, 30 A/m, Criteria A.										
EN 61000-4-11	AC Input transients [Reference EN 60601-1:2001] ¹ <table border="0" style="margin-left: 20px;"> <thead> <tr> <th><u>Condition</u></th> <th><u>Criteria</u></th> </tr> </thead> <tbody> <tr> <td>> 95% dip, 0.5 period</td> <td>A, 225 W</td> </tr> <tr> <td>60% dip, 5.0 periods</td> <td>B (A when Vin >230 Vac, 225 W)</td> </tr> <tr> <td>30% dip, 25 periods</td> <td>B (A when Vin >130 Vac)</td> </tr> <tr> <td>> 95% dip, 5 S</td> <td>B</td> </tr> </tbody> </table>	<u>Condition</u>	<u>Criteria</u>	> 95% dip, 0.5 period	A, 225 W	60% dip, 5.0 periods	B (A when Vin >230 Vac, 225 W)	30% dip, 25 periods	B (A when Vin >130 Vac)	> 95% dip, 5 S	B
<u>Condition</u>	<u>Criteria</u>										
> 95% dip, 0.5 period	A, 225 W										
60% dip, 5.0 periods	B (A when Vin >230 Vac, 225 W)										
30% dip, 25 periods	B (A when Vin >130 Vac)										
> 95% dip, 5 S	B										

Note 1 - For conditions where Criteria A cannot be met, characterize the boundary condition (Line and/or Load) where Criteria A becomes Criteria B. Ringwave Test 3 KV at 200 A, per ANSI 62.4.1.1, Criteria A.

ENVIRONMENTAL SPECIFICATIONS

Safety Certifications

The CPS250-M series power supply is intended for inclusion in other equipment and the installer must ensure that it is in compliance with all the requirements of the end application. This product is only for inclusion by professional installers within other equipment and must not be operated as a stand alone product.

Table 6. Safety Certifications for CPS250-M Series Power Supply System	
Standard	Description
ES60601-1	2 x MOPP and BF rated, Safety of medical electric Equipment.
CSA -C22.2 No. 601-1 M90	2 x MOPP and BF rated, Medical Equipment.
EN60601-1	2 x MOPP and BF rated, European Community Safety investigated and marketed by TUV or VDE.
UL62368-1	US and Canada Safety Requirements of Information Technology Equipment, including electrical business equipment.
CSA C22.2 No. 62368-1	Canada Safety Requirements of Information Technology Equipment, including electrical business equipment.
EN62368-1	European Community Safety investigated and marketed by TUV or VDE.
CE Mark	LVD
CCC / CQC	China Safety Approval
IEC62368-1	Audio/Video Information Technology and Communication Technology Equipment (CPS253-M1 only)
UKCA Mark	European Requirements

ENVIRONMENTAL SPECIFICATIONS

EMI Emissions

The CPS250-M series power supply has been designed to comply with the Class B limits of EMI requirements of EN55032 (FCC Part 15) and CISPR 32 (EN55032) for emissions and relevant sections of EN61000 (IEC 61000) for immunity.

Conducted Emissions

The power supply is tested under worst case conditions or AC input voltage, frequency and load conditions. The power supply will meet the following requirements with 6 dB margin across the frequency range; when tested on a wooden bench. This will be met with the output common floating or connected to ground. Additionally for single models the positive output connected to ground (operated as a negative output).

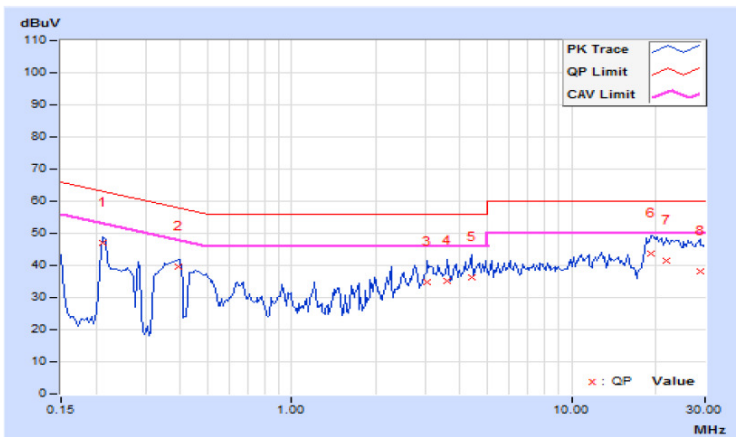

For class II operation, conducted EMI tested without ground plane or metal enclosure but all earth connection needs to be interconnected to meet class A limit. The EMI measurements are performed with resistive loads at maximum rated loading Sample of EN55032 Conducted EMI Measurement at 110 Vac input.

Note: Red Line refers to Advanced Energy Quasi Peak margin, which is 6 dB below the CISPR international limit. Pink Line refers to Advanced Energy Average margin, which is 6 dB below the CISPR international limit.

Conducted EMI emissions specifications of the CPS250-M series:

Parameter	Model	Symbol	Min	Typ	Max	Unit
FCC Part 15, Class A	All	Margin	6	-	-	dB
CISPR 32 (EN55032), Class A	All	Margin	6	-	-	dB

ENVIRONMENTAL SPECIFICATIONS

Radiated Emissions

Unlike conducted EMI, radiated EMI performance in a system environment may differ drastically from that in a stand-alone power supply. The shielding effect provided by the system enclosure may bring the EMI level from Class A to Class B. It is thus recommended that radiated EMI be evaluated in a system environment. The applicable standard is EN55032 Class A (FCC Part 15). Testing ac-dc convertors as a stand-alone component to the exact requirements of EN55032 can be difficult, because the standard calls for 1m leads to be attached to the input and outputs and aligned such as to maximize the disturbance. In such a set-up, it is possible to form a perfect dipole antenna that very few AC-DC convertors could pass. However, the standard also states that an attempt should be made to maximize the disturbance consistent with the typical application by varying the configuration of the test sample.

For appliance IEC protection Class I operation, CPS250-M series power supply meet Class A and B conducted and radiated EMI with ground plane LPX100 metal enclosure.

For appliance IEC protection Class II operation, Radiated EMI tested with ground plane to meet class A limit. Please refer to below for earth connections.

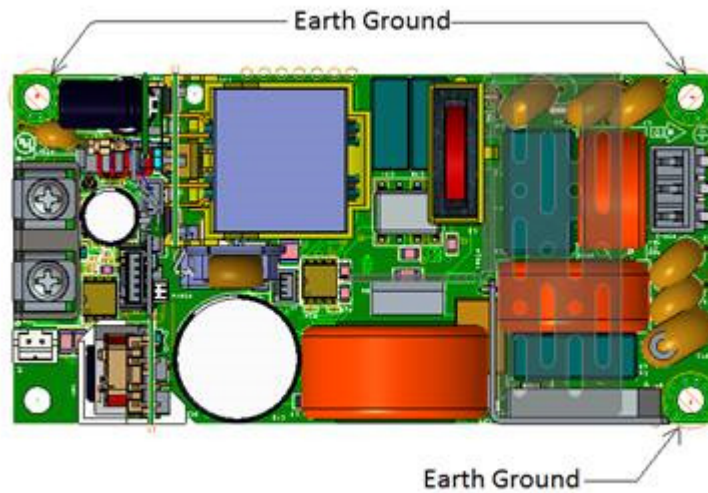

ENVIRONMENTAL SPECIFICATIONS

Operating Temperature

The CPS250-M series power supply will start and operate within stated specifications at an ambient temperature from the range of -20 °C to 50 °C.

Free Air Convection Cooling

The total output power rating is 155 W under free-air convection cooling at 50 °C and nominal input voltage ranges of 100 to 264 Vac.

Below 100 Vac and up to 50 °C, output current and power derates by 1%/Vac.

Above 50 °C the free-air convection rated power shall be derated at 2.5%/°C for input line voltage of 100 to 264 Vac.

Above 50 °C the free-air convection rated power shall be derated at 2.9%/°C up to 70 °C for input line voltage of 90 to 100 Vac.

AC Input (Vac)	Output Power (W)	Ambient Temperature (°C)
100-264	155	50
90-100	140	50
100-264	77.5	70
90-100	65.1	70

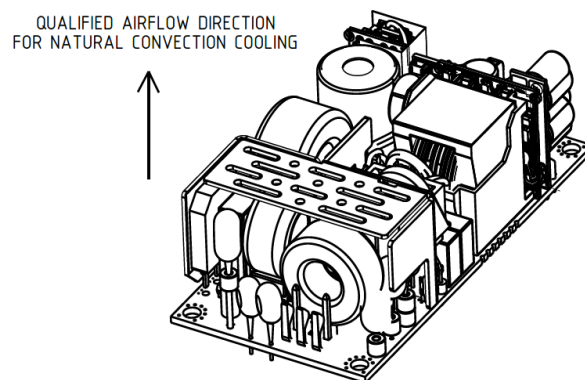

Figure 32: Qualified airflow direction for natural convection cooling

ENVIRONMENTAL SPECIFICATIONS

Forced Air Cooling

The total output power rating is 250 W under forced-air cooling at 50 °C and nominal input voltage ranges of 100 to 264 Vac. Below 100 Vac, and up to 50°C, output current and power derates at 1%/Vac.

The PSU shall be characterized with 4 airflow directions as shown in Figure 33 below. Airflow directions 1, 3 and 4 require 10 CFM (see table below for LFM conversion). Airflow direction 2 requires higher LFM of 300 (12 CFM). The airflow required shall be evaluated using a tunnel with cross sectional dimensions of 3.5" x 1.65" for Airflow directions 1 and 2, and 5.5" x 1.65" for Airflow directions 3 and 4. The power supply have safety approval at these various conditions.

Air flow direction	CFM	LFM
1	10 CFM	250 LFM
2	12 CFM	300 LFM
3, 4	10 CFM	160 LFM

At ambient above 50 °C the forced-air rated power shall be derated at 1.9%/°C up to 70 °C.

AC Input (Vac)	Output Power (W)	Ambient Temperature (°C)
100-264	250	50
90-100	225	50
100-264	155	70
90-100	139.5	70

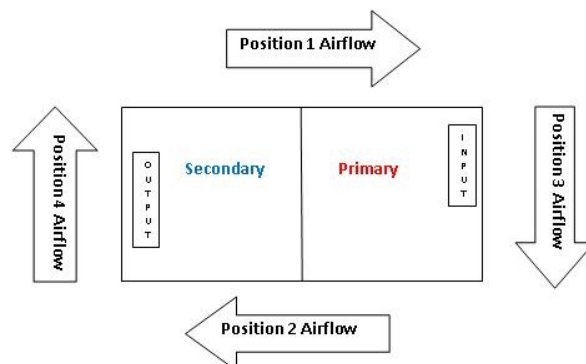

Figure 33: Airflow direction for forced air

ENVIRONMENTAL SPECIFICATIONS

Output power vs operating temperature

Derating conditions for AC input are summarized in Figures 34 and 35.

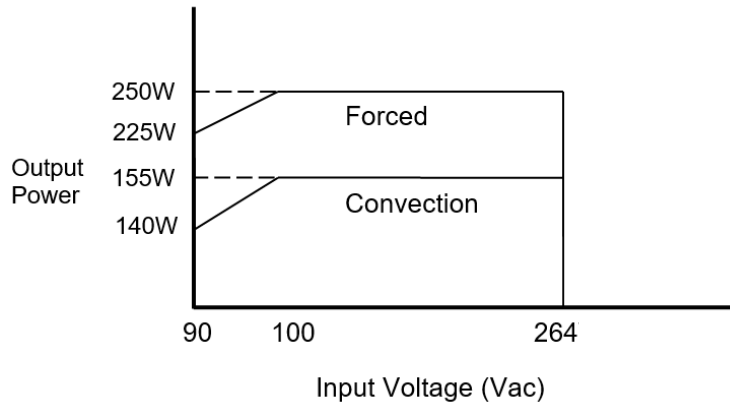

Figure 34: Derated Output Power vs. Input AC voltage

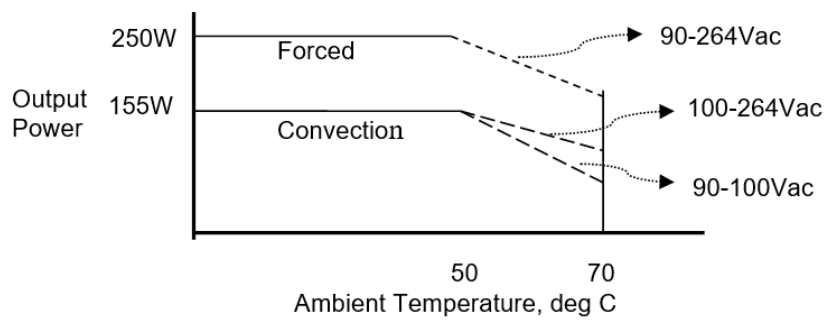

Figure 35: Derated Output Power vs. Ambient Temperature

The power supply derating under DC input conditions is the same as for AC input conditions, except 127 Vdc replaces 90 Vac, 140 Vdc replaces 100 Vac and 370 Vdc replaces 264 Vac. This is summarized in Figure 36 below.

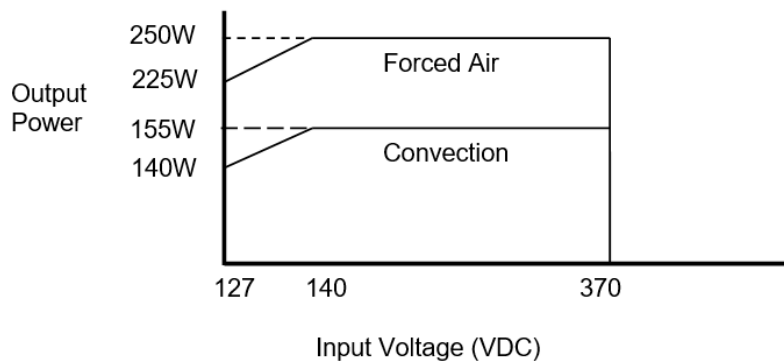

Figure 36: Derated Output Power vs. Input DC voltage

ENVIRONMENTAL SPECIFICATIONS

Free Air Convection Rating with Chassis (LPX100 enclosure)

The total output power rating is 155 W under free-air convection cooling at 35 °C and nominal input voltage ranges of 100 to 264 Vac.

Above 35°C the free-air convection rated power shall be derated at 1.72 %/°C for input line voltage of 100 to 264 Vac.

AC Input (Vac)	Output Power (W)	Ambient Temperature (°C)
100-264	155	35
100-264	48.36	70

Forced Air Rating with Chassis (LPX100 enclosure)

The total output power rating is 250 W under forced-air cooling at 50 °C and nominal input voltage ranges of 100 to 264 Vac.

Above 50 °C output power shall be derated at 1.9%/°C up to 70 °C with at least 12 CFM forced air cooling.

AC Input (Vac)	Output Power (W)	Ambient Temperature (°C)
100-264	250	50
100-264	155	70

ENVIRONMENTAL SPECIFICATIONS

Storage and Shipping Temperature / Humidity

The CPS250-M series power supply can be stored or shipped at temperatures between -40°C to $+85^{\circ}\text{C}$ and relative humidity from 5% to 95% non-condensing.

Altitude

The CPS250-M series power supply will operate within specifications at altitudes up to 5,000 meters above sea level for ITE and 3000 meters for medical over allowable temperature range with thermal derating. The power supply will not be damaged when stored at altitudes of up to 16,000 meters above sea level over allowable temperature range.

Humidity

The CPS250-M series power supply will operate within specifications when subjected to a relative humidity from 5% to 90% non-condensing. The CPS250-M series power supply can be stored in a relative humidity from 5% to 95% non-condensing.

Vibration

The CPS250-M series power supply pass the following vibration specifications:

Operating Random Vibration

Acceleration	4.0		gRMS
Frequency Range	8 – 200		Hz
Sweep Rate	1		Oct/min
Direction	3 mutually perpendicular axis		
PSD Profile	AMP/DISP	Frequency	Notes
	2G's	8-200Hz	X, Y, Z axis
	4G's	200-500Hz	X, Y, Z axis

Shock

The CPS250-M series power supply pass the following shock specifications:

Operating Half-Sine Shock

Acceleration	30	G
Duration	11	mS
Pulse	Half-Sine	
No. of Shock	3 positive and 3 negative pulses in each X, Y, Z axis	

POWER AND CONTROL SIGNAL DESCRIPTIONS

Main Output (J0) - 12V variant

Bus Bar connector provide the main output for the CPS253-M power supply. The Output Voltage and the Power Ground terminals are the positive and negative rails respectively of the main output of the CPS253-M power supply. The Main Output is isolated from the Earth Ground and can be operated as a positive or negative output.

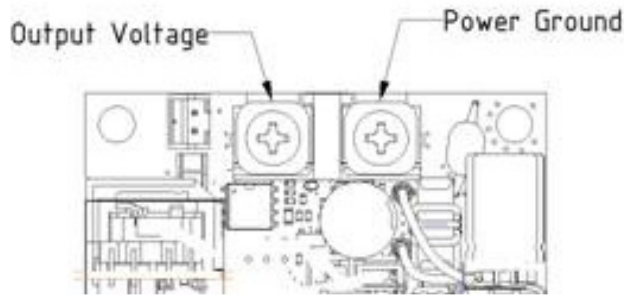

Main Output (J0) - 24, 48V variants

These terminals provide the main output for the CPS255-M / CPS258-M power supplies. The Main Output is isolated from the Earth Ground and can be operated as a positive or negative output.

Pin 1-3 - Main Output Return

Pin 4-6 - Main Output

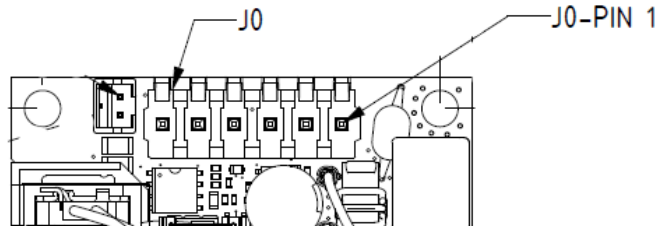

Main Output Voltage Adjustment (VR1)

The main output of the CPS250-M series can be adjusted by 0%~+10% from its nominal output voltage. The adjustment potentiometer is VR1. The potentiometer is sealed single-turn.

Please refer to table below for maximum output load setting beyond nominal output voltage during forced air conditions.

Trim%	Max Output Power (W)
0	250
5%	220
10%	200

VR1 Location for Output Adjust

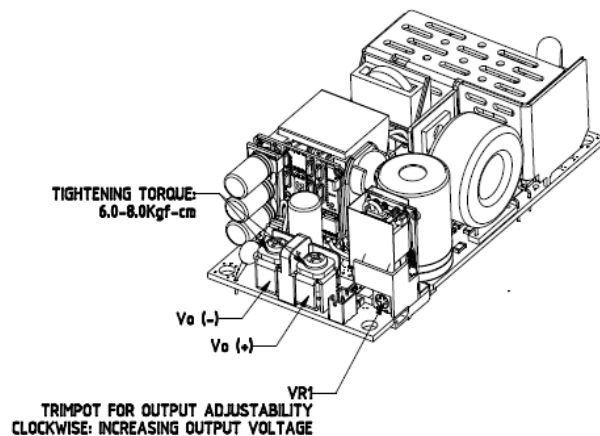

POWER AND CONTROL SIGNAL DESCRIPTIONS

Over Current Protection Trimpot (VR2)

A full power of 250 W is allowed if the OCP trimpot (location VR2) is turned fully clockwise. If the OCP trimpot is turned fully counter-clockwise, only 155 W is allowed. Output power of 155 W is intended for Convection cooling, while 250 W is intended for Forced Air cooling. If the OCP trimpot is set at Convection Power and 250 W is loaded, the unit will either protect through OCP, SCP or OTP which depends on the loading profile.

The OCP settings cannot be adjusted on the fly. It is required to recycle AC before new OCP settings can take effect. It is advisable to turn off the PSU before accessing the trimpot for end user safety.

VR2 Location for Setting Unit to Natural Convection (155 W max) or Forced Air Cooling (250 W max) operation

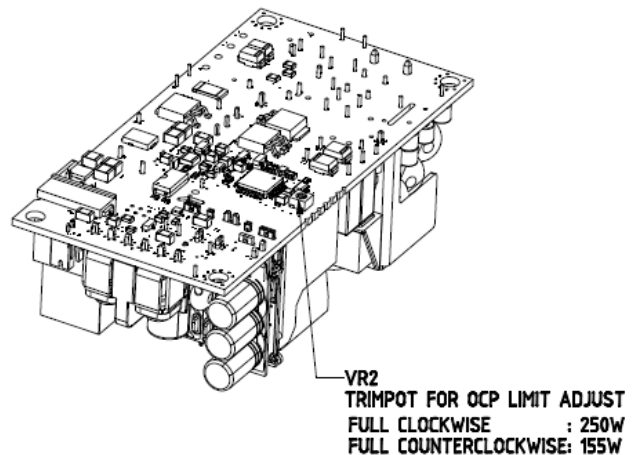

12V Fan Supply (J2)

The CPS250-M series power supply contains a separate 12 V output for powering a cooling fan. This 12 V Fan Supply is provided in 2-pin connector J2. The main output and fan output have common ground connection.

Pin 1 - Fan Return

Pin 2 - Fan Voltage

All models have a +12 V @ 0.5 A for fan cooling. This output is derived from the main transformer and shares a common ground. This output has short circuit protection. The power supply will protect itself in the event that this output is no longer functional in the event the power supply cooling depends on this output. Fan power should be considered as part of the total output power.

Except for the 12 V model, a minimum load required at main output for fan to have minimum fan voltage of 10 Vdc and for the fan output ripple to be <200 mV pk-pk.

Model	Minimum Load On Fan Output
12V	NA
24V	100mA
36V	150mA
48V	150mA

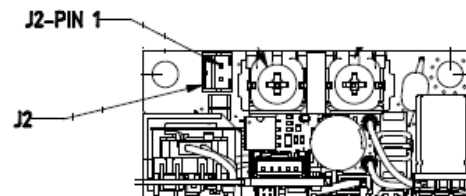

POWER AND CONTROL SIGNAL DESCRIPTIONS

Monitoring And Control Signals (J403) - For CPS253-M1 only

The CPS253-M1 contains a 5 pins control signal header providing monitoring and control signals.

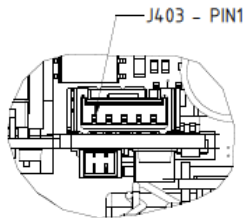

5V Standby Output, Standby Output Return - (Pin 1 and Pin 2 on J403)

5 V Standby Output at 100 mA is provided on the CPS253-M1 only.

Remote Inhibit - (Pin 3 on J403)

Remote inhibit will require Pin 3 of J403 to be grounded to Pin 2. Low voltage will also inhibit the power supply. Low is <0.8 V and high is ≥ 2.0 V, source current 1 mA maximum. Left the inhibit pin open will enable the power supply.

DCOK - (Pin 4 on J403)

It is a TTL logic signal that goes high 50-150 mS after output is in regulation. It goes low when the output goes out of regulation.

VFB (feedback loop pin) - (Pin 5 on J403)

This pin is an access to the Voltage loop error amp voltage feedback input and can be used for active current sharing purpose. Pulling this pin closer to output return will increase the output voltage. Maximum level that V_o can reach is around 8% typical when this pin is fully grounded.

APPLICATION NOTES

Output Ripple and Noise Measurement

The setup outlined in the diagram below has been used for output voltage ripple and noise measurements on the CPS250-M series. When measuring output ripple and noise, a scope jack in parallel with a 0.1 uF ceramic chip capacitor, and a 10 uF aluminum electrolytic capacitor should be used. Oscilloscope should be set to 20 MHz bandwidth for this measurement.

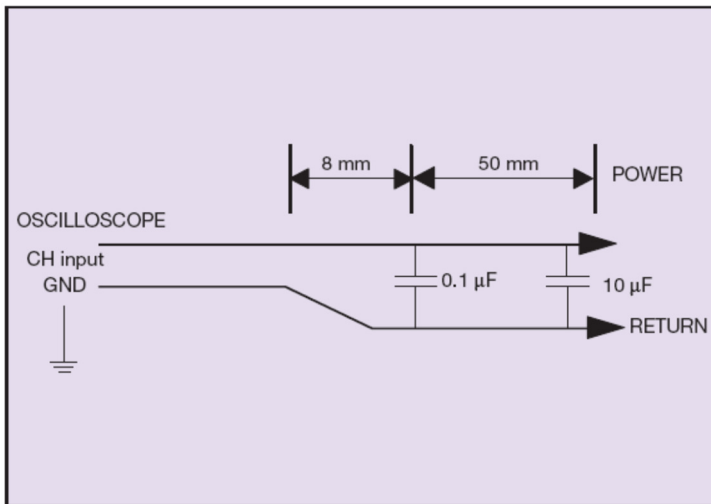

For all valid static conditions of line and load, the main output ripple is no more than 1% of the output voltage from 0 to 70 °C. Please refer to table below for minimum load required to meet 1% ripple requirement.

Please refer to table below for minimum load required to meet 1% ripple requirement. No ripple issue at absolute no load.

Model	Output Ripple Spec #1		Output Ripple Spec #2	
	Max. Limit	Min. Load	Max. Limit	Min. Load
CPS253-M / M1	1%	6 W	2.5%	50-300 mA
CPS255-M	1%	6 W	1.5%	50-200 mA
CPS258-M	1%	6 W	1.5%	50-150 mA

Note: For CPS258-M, a minimum of 330 uF system capacitance is required to meet 1% ripple for operation at ambient temperature 10 °C and below. The maximum output voltage trim that can meet 1% ripple is up to +5% only.

RECORD OF REVISION AND CHANGES

Issue	Date	Description	Originators
1.0	11.01.16	First Issue	E. Wang
1.1	01.07.17	Update Fan Output Description	E. Wang
1.2	01.18.17	Update Input Start-up & Under voltage Lockout Voltage	E. Wang
1.3	10.05.17	Update Performance Curves	E. Wang
1.4	10.14.18	Add the fan description for minimum load requirement	K. Wang
1.5	06.18.20	Update safety cert. to 62368-1	E. Wang
1.6	11.19.20	Update output power derating curve	E. Wang
1.7	07.30.21	Update efficiency curve	E. Wang
1.8	04.25.22	Add UKCA safety mark	K. MA



For international contact information,
visit advancedenergy.com.

powersales@aei.com (Sales Support)
productsupport.ep@aei.com (Technical Support)
+1 888 412 7832

ABOUT ADVANCED ENERGY

Advanced Energy (AE) has devoted more than three decades to perfecting power for its global customers. AE designs and manufactures highly engineered, precision power conversion, measurement and control solutions for mission-critical applications and processes.

Our products enable customer innovation in complex applications for a wide range of industries including semiconductor equipment, industrial, manufacturing, telecommunications, data center computing, and medical. With deep applications know-how and responsive service and support across the globe, we build collaborative partnerships to meet rapid technological developments, propel growth for our customers, and innovate the future of power.

PRECISION | POWER | PERFORMANCE

Specifications are subject to change without notice. Not responsible for errors or omissions. ©2020 Advanced Energy Industries, Inc. All rights reserved. Advanced Energy®, and AE® are U.S. trademarks of Advanced Energy Industries, Inc.